



PRODUCT CATALOGUE

GREASE, OIL, FUEL EQUIPMENT & INDUSTRIAL HOSE REELS

EXPORT EDITION

CONTENTS

Grease Equipment	1-20
Oil Equipment	21-52
Fuel Equipment	53-79
Hose Reels	80-118
Lighting	119-126



BUILT TO LAST SINCE 1948.

Macnaught is a proud Australian company.

Established in 1948, we have been designing and manufacturing high quality fluid and lubrication equipment for agricultural, industrial, automotive, transport and mining industries across the globe. Our range of grease pumps and guns, oil pumps and guns, fuel pumps, hose reels and flow meters are distributed to more than 70 countries.

We are the best in our class.

Our leadership position is due to a combination of innovative design, quality workmanship and dedicated people. People who not only understand the products we offer, but can provide expert advice and support when using them in some of today's most demanding industrial environments. It's this combination of qualities that puts daylight between us and our competitors. Macnaught products come with a 10-year mechanical warranty and guaranteed parts availability.



MANUAL GREASE GUNS

K29/K32 FLEXIGUN® 450g & 400g

10
YEARS
MACNAUGHT
WARRANTY*



Part Number	K29-01	K29-01-11	K32-01
Description	FLEXIGUN® 450g	FLEXIGUN® zinc	FLEXIGUN® 400g
KY SUPERGRIP™ coupler	✓	✓	✓
Flex extension	300mm (12")	300mm (12")	300mm (12")
Typical output pressure range*	34, 500 - 68, 900kPa (5, 000 - 10, 000psi)		
Output volume per shot	0.68g	0.68g	0.68g
Cartridge	450g (16oz)	450g (16oz)	400g (14oz)
Bulk fillable	✓	✓	✓
Max grease type	NLGI No.2	NLGI No.2	NLGI No.2
Wetted Parts	Aluminium, steel, nitrile rubber, cork and nylon. (Note- Zinc replaces Aluminium on K29-01-11)		



K29-12



FGK1-01 (WITH K29)
FGK1-02 (WITH K32)

Part Number	K29-12	FGK1-01	FGK1-02
Description	K29 in case with Cartridge	K29 in case with accessories & cartridge	K32 in case with accessories
FLEXIGUN® model	K29-01	K29-01	K32-01
Robust blow moulded case	✓	✓	✓
KY SUPERGRIP™ coupler	✓	✓	✓
450g (16oz) grease cartridge	✓	✓	✗
KIN hypodermic injector needle coupler	✗	✓	✓
KZDXL straight needle point coupler	✗	✓	✓

Recommended to be used with:



KYPLUS-01 Grease Coupler



ACK2-02 Aviation Kit



KZDXL Long Needlepoint Coupler

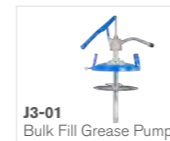

J3-01 Bulk Fill Grease Pump



PRV-25 Pressure Relief Valve

LEVERGUN™

Designed for high pressure, high volume greasing, this lever action grease gun can easily clear blocked or damaged grease nipples.

10
YEARS
MACNAUGHT
WARRANTY*

Lock the plunge rod into the follower for easier bleeding

Stepped barrel for easy grip
Robust zinc pull handle

Machined barrel thread makes it easier to screw to the head

Heavy duty 1.6mm thick barrel

KY SUPERGRIP™ 3 jaw high pressure coupler for positive connection

Screw fasteners for easy servicing. No rivets.

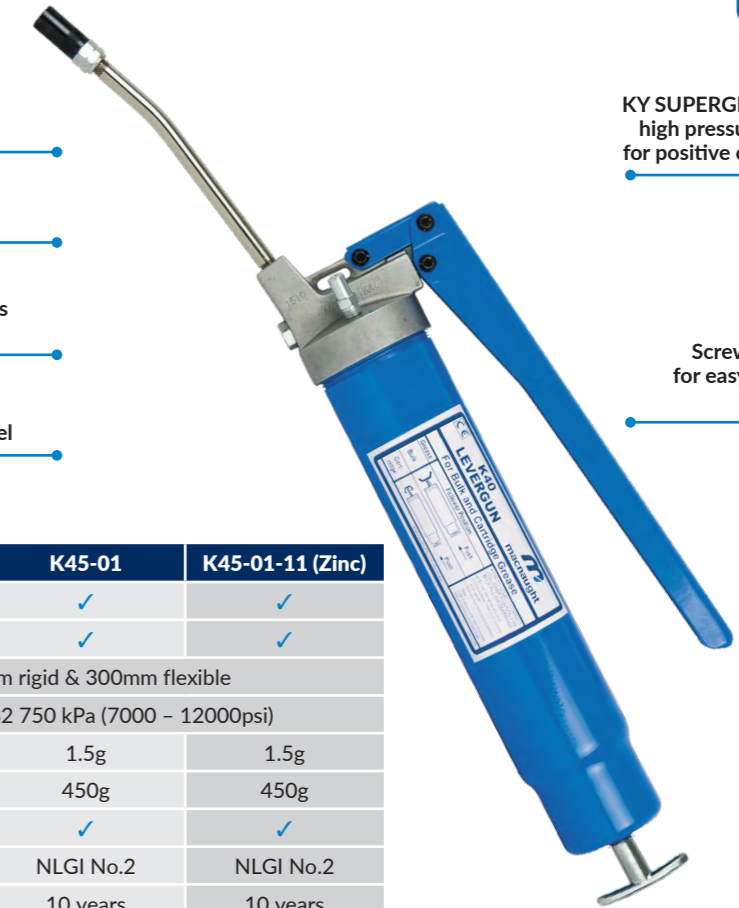

	K40-01	K45-01	K45-01-11 (Zinc)
KY SUPERGRIP™ coupler	✓	✓	✓
Fully serviceable	✓	✓	✓
Included Extensions	150mm rigid & 300mm flexible		
Typical output pressure range*	48 300 - 82 750 kPa (7000 - 12000psi)		
Output volume per shot	1.5g	1.5g	1.5g
Cartridge	400g	450g	450g
Bulk fillable	✓	✓	✓
Max grease type	NLGI No.2	NLGI No.2	NLGI No.2
Warranty ¹	10 years	10 years	10 years

*Output pressure is a product of input force provided by the operator.
Note¹ Subject to Macnaught warranty terms and conditions

J3-01 Grease Transfer Pump

An economical solution for refilling most standard grease guns from larger bulk pails. The standard J3 fills Macnaught's range of hand, air powered guns and mini-lube KT5 and KT6 containers.

	J3-01
J65 bulk fill nozzle	✓
Fully serviceable	✓
Extension	Rigid
Suits pail size	20kg
Output volume	54g per stroke
Max grease type	NLGI No.2
Warranty ¹	10 years

Note¹ Subject to Macnaught warranty terms and conditions



AIR GREASE GUN

K53 POWERPISTOL™ 450g Air-operated Grease Gun

The K53 POWERPISTOL™ is an air-powered single shot grease gun that combines portability with effortless one handed operation. Low air consumption makes the K53 POWERPISTOL™ ideal for use with truck and bus brake system air supply. Heavy duty pistol grip construction with comfortable ergonomics to suit 450g grease cartridges, bulk filling or Macnaught J3 grease transfer pump loading. The K53 POWERPISTOL™ is fully repairable with a strong die cast head and heavy gauge steel barrel for extra long service life.

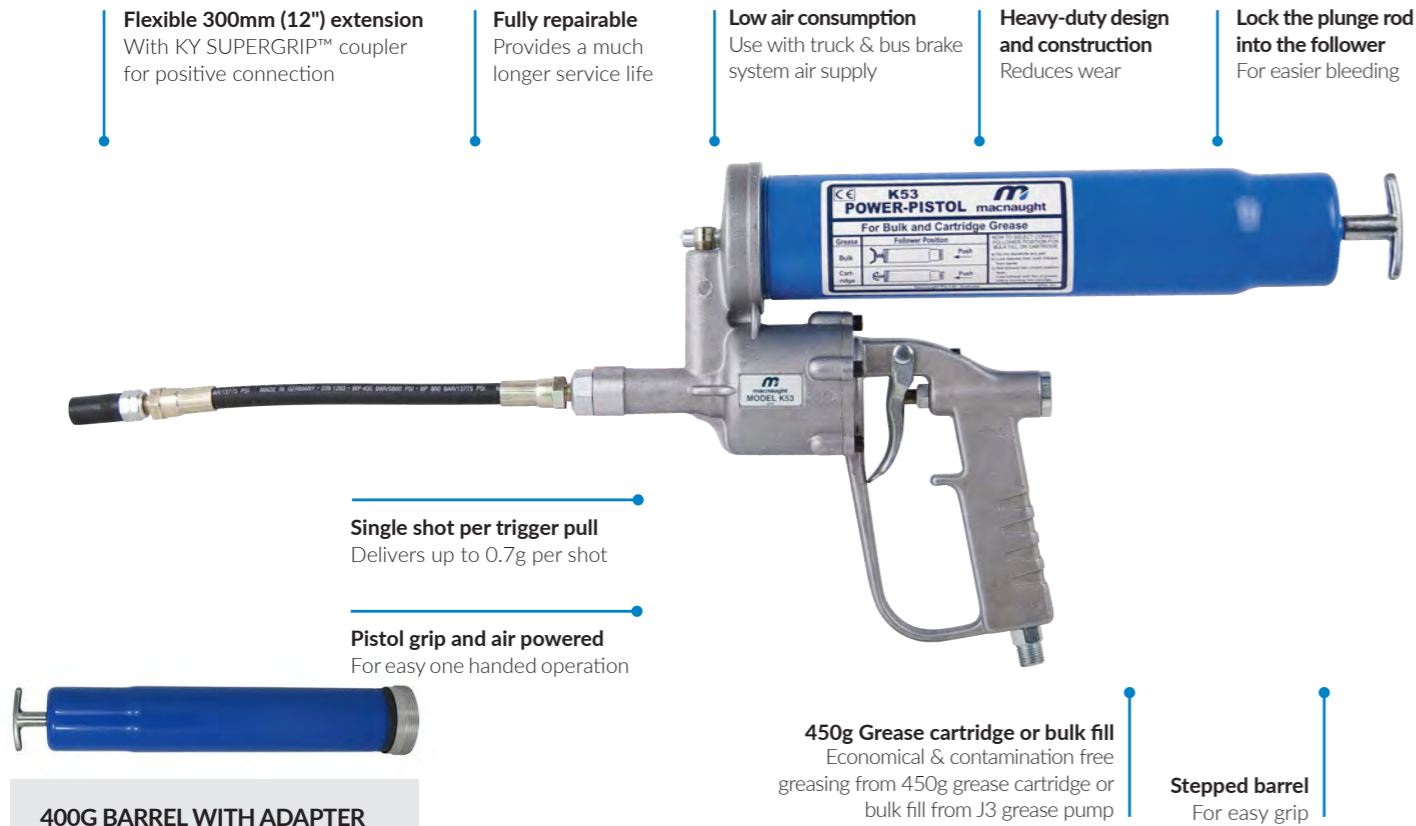

400G BARREL WITH ADAPTER
KF300-1K
Service Parts
K53-1K: Service Kit
K27-2K: Follower Kit (450g)

	K53-01
KY SUPERGRIP™ coupler	✓
Fully serviceable	✓
Extension	300mm flexible
Max output pressure	41.400 kPa (6000 psi)
Output volume per shot	0.7g
Recommended air pressure	620 kPa (90 psi)
Max air pressure	830 kPa (120 psi)
Min compressor size	0.026 M3/MIN (1 CFM)
Air inlet	1/4" BSP (M)
Cartridge	450g
Bulk fillable	✓
Max grease type	NLGI No.2
Warranty¹	10 years

Note¹ Subject to Macnaught warranty terms and conditions

MANUAL GREASE PUMPS



K7 MINILUBE® & K4 SUPERLUBE® Portable High Pressure System

Designed to offer powerful and professional greasing with robust portability, both MINILUBE® and SUPERLUBE™ products incorporate a spring loaded priming system to feed the KR PRESSURITE™ grease gun. Both systems are designed for those applications where compressed air is unavailable but bulk grease is preferred.

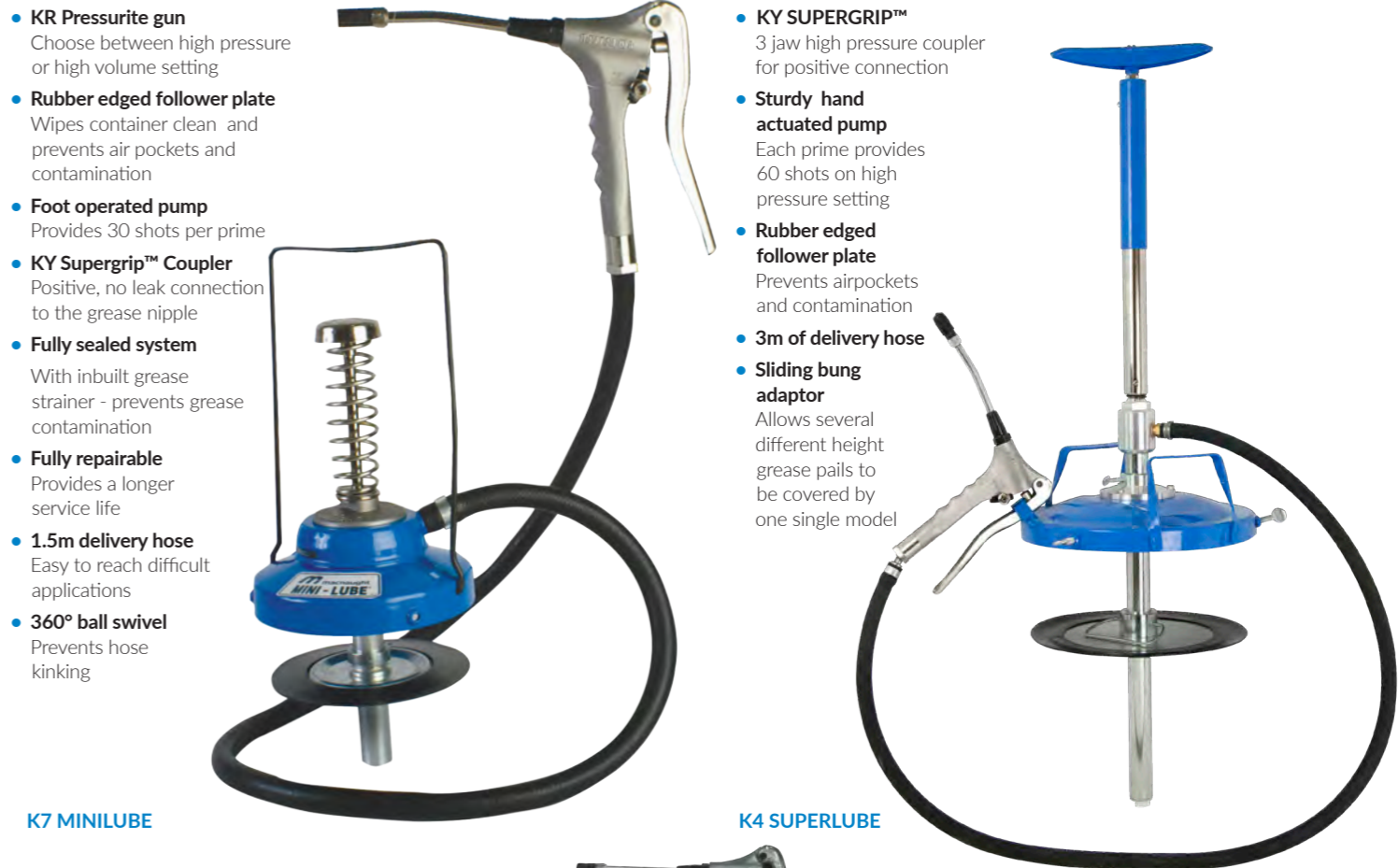

K7 MINILUBE

K4 SUPERLUBE

KR PRESSURITE™ GUN
KR
 Suitable for manual greasing equipment, comes standard with the K4 SUPERLUBE and K7 MINILUBE greasing systems

	K7-01	K7-24	K7-67	K4-01
KR PRESSURITE dual pressure grease gun	✓	✓	✓	✓
Fully serviceable	✓	✓	✓	✓
Pail size	2.5kg	2.5kg container	5kg container	20kg
Typical output pressure from KR PRESSURITE grease gun*	48 300 – 82 750 kPa (7000 – 12000psi) on high pressure setting			
Output per shot 'High Pressure' setting	0.45g	0.45g	0.45g	0.45g
Output per shot 'High Volume' setting	1.25g	1.25g	1.25g	1.25g
Output shots per prime	30	30	30	60
Bulk fillable	✓	✓	✓	✓
Max grease type	NLGI No.2	NLGI No.2	NLGI No.2	NLGI No.2
Warranty¹	10 years	10 years	10 years	10 years

*Output pressure is a product of input force provided by the operator. Note¹ Subject to Macnaught warranty terms and condition..

AIR OPERATED GREASE PUMPS



P3 POWERLUBE™ Portable Air-Operated 20kg Greasing System

The P3 POWERLUBE™ is a premium quality, reliable, 50:1 air-operated greasing system that is excellent for high volume grease users that have many applications and require continuous high pressure greasing. This portable grease dispensing system is suitable for 20kg pails and is equipped with a low air consumption motor that doesn't need to be lubricated due to the use of modern polymer materials. Users will save on power and the oily mist and mess associated with air operated equipment is gone. Suitable for underground coal mine applications.



50:1 Ratio Air Motor
Delivers up to 460g/min

Quiet Air Motor Design
Meets all industry noise level standards. Doesn't require air-line lubricator

Adjustable Collar System
To accommodate different height 20kg (or similar size) grease pails

B2 Booster Gun
Boosts pressure up to 10,000psi to clear blocked grease nipples

Rubber-Edged Follower Plate
Prevents air pockets & contamination

KY Supergrip Coupler
Positive no-leak connection

360° ZSB Swivel
Improves manoeuvrability and offers easier one-handed operation

Fully Sealed with Grease Strainer
Delivers clean contamination free grease

Fully Repairable
Provides a much longer service life

4m High Pressure Grease Hose
Allows access to hard to reach applications



Features & Benefits

- Zinc components - For underground mining compatibility
- Air-operated system with up to 460g/min (16 oz/min) grease delivery - Fast, efficient greasing.
- Non-corroding air motor design - No airline lubricator required. Easy and low cost to repair.
- Quiet air motor design - Meets all industry noise level standards
- 4m high pressure grease hose - Extra hose length for easier access to difficult applications.
- B2 Booster Gun - Boosts greasing pressure up to 10,000psi when required.
- 360° ZSB Swivel - Improves greasing flexibility and offers easier one handed operation.
- KY Supergrip 3 jaw high pressure coupler - Positive no leak connection.
- Rubber edged follower plate - Prevents air pockets and contamination.

- Fully sealed greasing system with in-built grease strainer - Clean grease delivery every time.
- Fully repairable - Provides a longer service life.

REPAIR KITS

- P3-5K: Pump Seal Kit
- P3-1K: Air Motor Seal Kit
- P3-3K: Seal Kit
- PA30s: Valve Body Complete

Applications:

Automotive, Truck and Buses, Farming Equipment, Textile Machinery, Construction and Earthmoving, Forklifts, Military Equipment (e.g. tanks, armoured vehicles), Mining Machinery, Aircraft, Trains

POWERLUBE™

MAXILUBE™



P3-01C (20kg)

P3-01CTROLLEY (15-20kg)



P6-01 (55kg)

P6-01TROLLEY (55kg)



P8-11 (180kg)

P8-11TROLLEY (180kg)



P3-OS2 (15-25kg)

	P3-01C - powerlube®	P3-OS2 - powerlube® portable greasing system	P6-01 - maxilube®	P8-11 - maxilube®
	portable dispensing system	complete system with enclosed trolley	portable dispensing system	complete grease dispensing system
Pump ratio	50:1 Ratio	50:1 Ratio	50:1 Ratio	50:1 Ratio
Max pump output pressure	51 700kPa (7500psi)	51 700kPa (7500psi)	51 700kPa (7500psi)	51 700kPa (7500psi)
Max gun output pressure	68 900 kPa (10 000psi)	68 900 kPa (10 000psi)	68 900 kPa (10 000psi)	68 900 kPa (10 000psi)
Bare pump	P3001	P6001	P6001	P8001
Suited to pails	20kg	12.5 - 25kg	55kg	180kg
Hose	4m x 6mm ID delivery hose	4m x 6mm ID delivery hose	4m x 6mm ID delivery hose	2.5m x 6mm ID delivery hose
Control gun	B2 Booster Gun c/w ZSB swivel	B2 Booster Gun c/w ZSB swivel	B2 Booster Gun c/w ZSB swivel	B2 Booster Gun c/w ZSB swivel
Trolley	✓ TR20G	✗	✓ TR20G	✓ TR205 - 180kg Trolley
Output	460g/min	460g/min	460g/min	460g/min
Airline lubricator	not required	not required	not required	not required
Fully serviceable	✓	✓	✓	✓
Warranty¹	10 years	10 years	10 years	10 years
Grease viscosity	up to NLGI No.2	up to NLGI No.2	up to NLGI No.2	up to NLGI No.2
Wetted components	Zinc, Hard Chrome-Plated Carbon Steel, Brass, Nitrile and Polyurethane rubber			
Max air pressure	150psi	150psi	150psi	150psi
Min air pressure	60psi	60psi	60psi	60psi
Air inlet	1/4" NPT (F)	1/4" NPT (F)	1/4" NPT (F)	1/4" NPT (F)
Pump outlet	1/4" NPT (F)	1/4" NPT (F)	1/4" NPT (F)	1/4" NPT (F)
Min compressor size	0.08m ³ /min (3 cfm)	0.08m ³ /min (3 cfm)	0.08m ³ /min (3cfm)	0.08m ³ /min (3cfm)

Note¹ Subject to Macnaught warranty terms and conditions

AIR OPERATED GREASE GUNS

Dual Action Air Operated Grease Guns

Macnaught are the Air Operated Dual Action Grease Guns, which come complete with a 750mm flexible extension and KY grease coupler. The high quality and heavy duty construction, allows you to easily switch between continuous grease flow operation or a single shot, whatever your requirement.



Macnaught heavy duty stepped grease barrel with lockable plunger



Durable Aluminium die cast head with precision honed internal bore

Switch between continuous grease flow operation and on demand single shot

High Pressure 750mm long grease hose with KY coupler

Bulk loader that doubles as an air bleeder

Ergonomic pistol grip design for balance and ease of use

	K57-01	K58-01	K58-02
Grease Capacity	450g	400g	400g
Ratio		45:1	
Output Pressure		Up to 6000psi	
Continuous Delivery		Up to 400g/m	
On Demand Single Shot		0.9g	
Air Inlet Pressure Range		40 - 120psi	
Air inlet		1/4" BSP (F)	
Supplied with Nitto Style Air plug Connector		1/4" BSP (F)	
KY Coupler	1/8"BSP(F)	1/8"BSP(F)	1/8"NPT(F)

GREASE PUMP



Foot Operated 10kg Bucket Pump

Macnaught Foot Operated 10kg Bucket Grease Pump, which also includes a 2m HP grease hose, inline swivel, dispensing handle and coupler for ease of use.



Hands free pump operation

Produces up to 8700psi

Operational up to and including NLGI no2 greases

Portability through sturdy swing away carry handle

Heavy duty powder coated steel construction for durability

	K8-01
Grease Capacity	10kg
Output Pressure	Up to 8700psi
Per Stroke	2g

AIR OPERATED GREASE PUMPS

BATTERY POWERED GREASE GUN



Portable trolley based grease dispensing system

Portable trolley based grease dispensing system to suit 180kg (400lb) grease drums. The system includes TR205 trolley, GR215K grease reel and a P8 (50:1) ratio air operated grease pump. Complete with all fittings and hoses.



	GS100-01 - Portable Trolley Based Greasing System	SGS100-01 - POWERLUBE™ Stationary Grease System - 180kg
Feature	Complete greasing system	
Pump ratio	50:1 Ratio	
Max pump output pressure	51 700kPa (7500psi)	
Max gun output pressure	68 900 kPa (10 000psi)	
Bare pump	P8001 - maxilube®	
Suited to pails	180kg	
Hose	GR215K grease reel (15m x 6mm)	
Control gun	B2 Booster Gun c/w ZSB swivel	
Output	460g/min	
Airline lubricator	not required	
Fully serviceable	✓	
Warranty¹	10 years	
Grease viscosity	up to NLGI No.2	
Max air pressure	150psi	
Min air pressure	60psi	
Air inlet	1/4" NPT (F)	
Trolley Included	✓	✗

The system is designed for all type of workshop applications where reliable and portable greasing is required.

- B2 Booster grease gun
- All necessary fittings and hoses

Applications:

Automotive, Truck and Buses, Farming Equipment, Textile Machinery, Construction and Earthmoving, Forklifts, Military Equipment (e.g. tanks, armoured vehicles), Mining Machinery, Aircraft, Trains

Note¹ Subject to Macnaught warranty terms and conditions

PG450 POWERGUN™ High Performance Li-Ion Grease Gun

The POWERGUN™ 18V Li-Ion battery powered grease gun built with the demanding Australian conditions in mind. This powerful heavy duty grease gun is portable, durable and can move grease quickly or at high pressure via the high/low volume valve. The POWERGUN™ includes a smart carry case with a spare 18V Li-Ion battery for added longevity and portability and a 1 hour fast charger for continuous operation.



POWERGUN™



18V Lithium-Ion battery
Lightweight, long life for continuous pumping

SUPERGRIP™ KY Coupler
Leak free connection

Ergonomic design
With stable free-stand capability



LED light
To light dark areas and locate grease ripples

Spring loaded bleeder valve
To simplify new cartridge bleeding

1m long flexible extension
To reach hard to get grease nipples

Part Number	PG450
Description	POWERGUN™ 18V Battery Operated Grease Gun
KY® High Pressure Grease Coupler	✓
Included	2 x 3.0Ah Li-Ion batteries 1 x 90 minute fast charger 1m flexible hose Shoulder strap
Typical output pressure range	58, 600kPa (8, 500psi)
Output volume per shot	150g/min
Cartridge	450g (16oz)
Max grease type	NLGI no 2
Wetted Parts	Aluminium, mild steel, nitrile rubber

Why choose this product?

Reliable continuous greasing

Service Parts

- K27-2K: Follower Kit
- PGC-3A: PG450 Spare Battery Charger(3.0Ah)
- PGB-3A: PG450 Spare Battery(3.0Ah)
- PGH: PG450 Grease Hose 1 meter

Applications:

Suitable for all type of greasing applications

KY+ Safety Grease Coupler

The innovative KY+ and KY+XL grease coupler is a game changer in equipment maintenance. In fact, for any high grease application, KY+ delivers improved access, productivity and safety through a new patented design. The “superior interior” is the KY+ difference. KY+ and KY+XL is more versatile, reliable, leak free and easy to use. The KY+XL nose is 2.5”(64mm) longer than the KY+.



Patent Approved Quick & Easy Release Mechanism



Internal Pressure Relief



P/N: KYPLUS-01

P/N: KYPLUSXL-01

Superior Safety

Compact Design

Original KY Floating Jaw

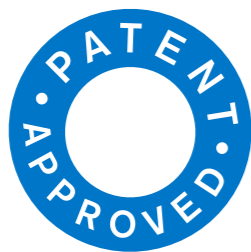

Service Parts
• KYPLUS-1K: Overhaul Kit

Applications:
Automotive, Truck and Buses, Farming Equipment, Textile Machinery, Construction and Earthmoving, Forklifts, Military Equipment (e.g. Tanks, armoured vehicles), Mining Machinery, Aircraft, Trains

(Australian Patent No. 2018256611. International Patent Application No. PCT/AU2018/050651)

KY+ Safety Grease Coupler Range

Blister Packaging



Counter Display

KYPLUS-01-10 (BSP)
KYPLUS-02-10 (NPT)
KYPLUS-03-10 (M10X1)

KY+ 10 Trade Pack

KYPLUS-01TP (BSP)
KYPLUS-02TP (NPT)

KY+ 100 Trade Pack

KYPLUS-01TP-100 (BSP)
KYPLUS-02TP-100 (NPT)

Counter Display

KYPLUSXL-01-10 (BSP)
KYPLUSXL-02-10 (NPT)
KYPLUSXL-03-10 (M10X1)

PART NUMBER	DESCRIPTION	THREAD TYPE	MAX WORKING PRESSURE:	COUPLER QUANTITIES
KYPLUS-01	KY+ Grease Coupler - BSP	1/8" BSP	10,000psi (68,900kPa)	1
KYPLUS-02	KY+ Grease Coupler - NPT	1/8" NPT		1
KYPLUS-03	KY+ Grease Coupler - M10X1	M10X1 (F)		1
KYPLUS-01-10	KYPLUS Grease Coupler - BSP (Counter Display - 10's pack)	1/8" BSP		10 (in blister packs)
KYPLUS-02-10	KYPLUS Grease Coupler - NPT (Counter Display - 10's pack)	1/8" NPT		10 (in blister packs)
KYPLUS-03-10	KYPLUS Grease Coupler - M10X1 (Counter Display - 10's pack)	M10X1 (F)		10 (in blister packs)
KYPLUS-01TP	KYPLUS Grease Coupler - BSP (Trade Pack - 10 Units)	1/8" BSP		100 Units
KYPLUS-02TP	KYPLUS Grease Coupler - NPT (Trade Pack - 10 Units)	1/8" NPT		100 Units
KYPLUS-01TP-100	KYPLUS Grease Coupler - BSP (Trade Pack - 100 Units)	1/8" BSP		100 Units
KYPLUSXL-01	KYPLUSXL Grease Coupler - BSP	1/8" BSP		1
KYPLUSXL-02	KYPLUSXL Grease Coupler - NPT	1/8" NPT	1	
KYPLUSXL-03	KYPLUSXL Grease Coupler - M10X1	M10X1 (F)	1	
KYPLUSXL-01-10	KYPLUSXL Grease Coupler - BSP (Counter Display - 10's pack)	1/8" BSP	10 (in blister packs)	
KYPLUSXL-02-10	KYPLUSXL Grease Coupler - NPT (Counter Display - 10's pack)	1/8" NPT	10 (in blister packs)	
KYPLUSXL-03-10	KYPLUSXL Grease Coupler - M10X1 (Counter Display - 10's pack)	M10X1 (F)	10 (in blister packs)	

AIR OPERATED GREASE PUMPS



P58 MAXILUBE™ Heavy Duty Air Operated Grease Pump

The Macnaught P58 MAXILUBE™ (58:1) is a high pressure, high performance grease pump designed for use in the harshest of conditions. The heavy duty construction provides reliable on demand greasing over long greasing distances.



58:1 Ratio Air Motor

Heavy duty construction
Reliable long service life

High flow up to 6kg/min (free flow)
Fast high pressure greasing

High quality components
To ensure reliable operation in the harshest environments

Large silencer
Prevents icing and reduces noise



P58-01

Quick grease line pressure recovery
Instant greasing

High pressure / high volume pump
Ideal for large workshops with long greasing distances

Fully Repairable
Spare parts availability

Heavy Duty Construction
Reliable long service life

P58 MAXILUBE™ Grease Pumps



Accessories	
Lid & Follower Plate - 180Kg	P58LF-01
Pipe Adaptor Kit	TA-2K
Airline Oil Lubricator Kit	TA-3K
Air Filter and Regulator Kit	TA-7K
Grease hose - 2.5m	PF8
Grease hose - 4m (optional)	PF6
Booster Gun	B2-01
Graco to Macnaught adaptor	TJ061A
3" Camlock Adapter Kit	TJ062A



P58-01



P58PLF-01



P58PGLF-01

Part Number	P58-01	P58PLF-01	P58PGLF-01
Description	P58 Grease Pump - 180 KG	P58 Grease Pump Kit - with Lid and Follower - 180Kgs	P58 Grease Pump Kit - with Booster Gun, Lid and Follower - 180Kgs
Pressure Ratio	58:1	58:1	58:1
Air Pressure Operating Range	60 to 150psi	60 to 150psi	60 to 150psi
Air Consumption	23.5 SCFM (@120psi pressure, 20°C)	23.5 SCFM (@120psi pressure, 20°C)	23.5 SCFM (@120psi pressure, 20°C)
Max Fluid Outlet Pressure	8700psi (59, 900 kPa)	8700psi (59, 900 kPa)	8700psi (59, 900 kPa)
Air Motor Diameter	4.1" (104.7mm)	4.1" (104.7mm)	4.1" (104.7mm)
Max free Flow Delivery Rate	6 kg/min (13lb/min) (@120psi pressure, 20°C)	6 kg/min (13lb/min) (@120psi pressure, 20°C)	6 kg/min (13lb/min) (@120psi pressure, 20°C)
Air Inlet Size	1/4" BSPT	1/4" BSPT	1/4" BSPT
Fluid Outlet Size	3/8" BSPT	3/8" BSPT	3/8" BSPT
Wetted and Seal Materials	NBR	NBR	NBR
Noise Level	85 dB(A) (@120 psi)	85 dB(A) (@120 psi)	85 dB(A) (@120 psi)
Air Lubricator Included	Yes	Yes	Yes
Hose	X	X	2.5m x 6mm ID Delivery Hose
Control Gun	X	X	B2 Booster Gun with Z Swivel
Lid and Follower(180 kgs)	X	Lid and Follower - 180kgs (P58LF-01)	Lid and Follower - 180kgs (P58LF-01)
Grease up to	NLGI no 2	NLGI no 2	NLGI no 2
Pump Tube Diameter	41.3 mm O.D.	41.3 mm O.D.	41.3 mm O.D.
Pump tube height	960 mm	960 mm	960 mm
Total height	1396 mm	1396 mm	1396 mm
Weight	13 kgs	13 kgs	13 kgs

Service Parts

- P58-1K: Air Motor Overhaul Kit
- P58-3K: Seal Kit
- P58-2K: Lower Pump Service Kit

Applications:

For use in installations where long distance high pressure greasing is required

GREASE ACCESSORIES



B2-01

BOOSTER GUN**B2-01**

- Delivery pressure up to 689bar/68,950Pa (10,000psi)
- Used for high pressure delivery with any air-powered grease pump
- Increases the inlet grease pressure to overcome line resistance or nipple blockages
- 1/4" NPT(F) inlet



B2-SG

BOOSTER GUN WITH SAFETY GUARD**B2-SG**

Booster gun with safety guard. Fitted with trigger hand guard to protect the operator

REPAIR KITS

- **KY3S:** Pack of 8 SUPERGRIP™ Grease Coupler Seals

12
MONTH
MACNAUGHT
WARRANTY
**FLEXILUBE GREASE
FB2-450**

450g (16oz) grease cartridge - carton of 12 water resistant lithium complex type lubricant (NLGI2) - multipurpose grease for high temperature applications.

**DRUM COVER AND FOLLOWER PLATE FOR P8
POWERLUBE™****P8LF-01**

Tough powder coated steel drum cover, rubber edged follower plate with handle and release valve. Fits 180kg/ 400lb grease drums

**STRAIGHT NEEDLEPOINT COUPLER****KR**

Ideal for greasing the bearings on four wheel drive vehicles. Length 120 mm (4 3/4").

**STRAIGHT NEEDLEPOINT COUPLER****KDA**

Ideal for greasing the bearings on four wheel drive vehicles. Length 120 mm (4 3/4").

**GREASE FITTING UNBLOCKER****GFU**

Opens clogged grease fittings and loosens hardened grease joints. Excellent for maintaining and protecting bearings, control arms, joints, king pins, etc. Comes complete with grease coupler for connection onto the grease fitting and 2 spare seals for replacing the piston seals as they wear

**BULK FILL ADAPTOR ASSEMBLY****J65**

Filler adaptor assembly for the J3 grease transfer pump. Allows connection to the filler/bleeder valve to refill cartridge guns from bulk grease pails

12
MONTH
MACNAUGHT
WARRANTY

12
MONTH
MACNAUGHT
WARRANTY
**DRUM TROLLEY - 20KG****TR20G**

Multi-purpose drum trolley to suit both 20Kg (44lb) and 55kg (120lb) grease drums

**DRUM TROLLEY - 180KG****TR205-01**

Heavy duty trolley designed to suit drums up to 180kg (400lb). Large main wheels with a steerable braked third wheel. Very low loading height.

**DRUM TROLLEY - 20KG****TR5-01**

Drum trolley for 20kg (44lb) grease drums

DRUM TROLLEY - 55KG**TR6-01**

Drum trolley for 55kg (120lb) grease drums

GREASE ACCESSORIES

Aviation Kit

The ACK2 grease kit is a comprehensive range of greasing couplers required for the maintenance of aircraft and associated equipment. This kit has been developed in consultation with the aviation industry to fill their specific requirements. The ACK2 greasing kit would also suit any industry that has varied greasing applications requirements, specifically for hard to reach and access grease nipples.



Blow moulded plastic case

Long clip on 21"(530mm) flexible extension

Various length & angle needle point couplers

2 x short 90° couplers (needle point & standard)

Long Hypodermic needle



Features & Benefits

ACK2 is the complete coupler kit. Includes a blow moulded carry case .

- KDN Right angle needlepoint
- KDS Right angle standard coupler
- KDE8 Quick connect 8" steel extension with coupler
- KDF21 Quick connect 21" flexible extension with coupler
- KY Standard coupler
- KZDXL 120mm long needlepoint coupler
- KZHY 130mm hypodermic needle coupler
- KLNJ 300mm long needlepoint coupler with J bend
- KZLNS 300mm straight needlepoint coupler
- KZLNR 300mm long needlepoint coupler with 90° tip
- KZLN45 300mm long needlepoint coupler with 45° tip
- KZSNR 110mm needlepoint coupler with 90° tip
- J65 Bulk fill nozzle



RIGID EXTENSION - 8" KDE8

Push-on rigid grease extension - 200mm (8"). Useful to temporarily extend reach capacity on existing rigid or flexible extensions fitted



FLEXIBLE EXTENSION - 13" KDF13

Push-on flexible grease extension - 330mm (13"). Can be used to temporarily extend existing rigid or flexible extensions



FLEXIBLE EXTENSION - 21" KDF21

Push-on flexible grease extension - 530mm (21"). Can be used to temporarily extend existing rigid or flexible extensions



FLEXIBLE EXTENSION - 12" KF9

Flexible grease extension - 300mm (12"). Suitable for both hand or powered greasing equipment; 1/8" BSP (M) fittings on both ends



FLEXIBLE EXTENSION - 17" KF17

Flexible grease extension - 430mm (17"). Suitable for both hand or powered greasing equipment; 1/8" BSP (M) fittings on both ends



FLEXIBLE EXTENSION - 17" PF17

430mm (17") flexible extension. Suitable for powered greasing equipment. 1/8" BSP (M) on both ends



RIGID/FLEXIBLE EXTENSION - 17" KFR

Flexible/rigid grease extension - 330mm (13"). Useful tool to allow the operator both flexible or rigid extensions by simply moving the sleeve forward or back



HIGH PRESSURE FLEXIBLE EXTENSION - 12" PF9

300mm (12") high pressure flexible extension suitable for use with air operated greasing equipment. 1/8" BSP (M) on both ends



EXTENSION HOSE - 4m x 6mm PF6

4.0m x 6mm i.d. high pressure grease delivery hose. 1/4" NPT (M) on both ends



FLEXIBLE EXTENSION - 30" KF30

Flexible grease extension - 760mm (30"). Suitable for both hand or powered greasing equipment



HIGH PRESSURE DELIVERY HOSE - 30" PF30

760mm (30") high pressure grease delivery hose. 1/4" NPT (M) on both ends



EXTENSION HOSE - 2.5m x 6mm PF8

2.5m x 6mm i.d. high pressure grease delivery hose. 1/4" NPT (M) on both ends



GREASE CONTAINER - 2.5KG KT5

2.5kg Reusable grease container to suit K7-01

GREASE CONTAINER - 5KG KT6

5kg Reusable grease container to suit K7-67



STRAIGHT NEEDLEPOINT COUPLER KZDXL

Ideal for greasing the bearings on four wheel drive vehicles. Length 120 mm (4 3/4").

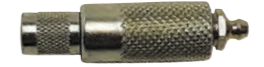

CONCAVE NIPPLE COUPLER KZE

Push-on concave grease coupler - 60mm (2.25"). Temporary connector where special or damaged type nipples are encountered



GREASE INJECTOR NEEDLE KIN

Push-on grease injector needle. Used to dispense grease into sealed bearings and steering components if normal nipples aren't available



STANDARD BUTTONHEAD COUPLER KSR

Push-on standard button head grease coupler - 5/8". Easy connect/disconnect coupler to allow greasing of the smaller buttonhead type fittings



GIANT BUTTONHEAD COUPLER KGR

Push-on giant button head grease coupler - 7/8". Easy connect/disconnect coupler to allow greasing of the larger buttonhead type fittings



360° SWIVEL ZSB

"Z" Type high pressure grease swivel. Used to overcome difficulty by operator to grease hard to reach lube points 1/8" NPT (M) x 1/4" NPT (F)



RIGHT ANGLE COUPLER KDR

Push-on right-angle coupler - Standard temporary attachment for greasing in tight areas where access by a standard coupler isn't available



NEEDLEPOINT COUPLER RIGHT ANGLE KDN

Push-on right-angle needlepoint extension. Used for temporary attachment to grease in difficult applications where using a normal coupler is impossible to use



NEEDLENOSE COUPLER KZD

Used when nipples are recessed and standard couplers would meet with interference from surrounding components (universal joints, etc). Length 93 mm (3 3/4")



NEEDLEPOINT COUPLER HYPODERMIC KZHY

Push-on hypodermic grease coupler - 130mm (5.125"). Temporary coupler for use with bearings which have rubber dust covers where the standard KIN coupler won't reach



COUPLER KY (1/8" BSP)

Standard SUPERGRIP™ coupler supplied with all Macnaught grease guns. Designed to fit most grease nipples and grease guns.

Additional Options

KY2P 1/8" (F) BSP Coupler pack of 2
KY-10 1/8" (F) BSP Coupler pack of 10
KY-50 1/8" (F) BSP Coupler pack of 50
KY-N 1/8" (F) NPT Coupler
KY-M M10X1 (F) Coupler

Service Parts

KY3S Pack of SUPERGRIP™ Grease Coupler Grease Coupler Seals



NEEDLEPOINT COUPLER 90° (12") KZLNR

Push-on needlepoint grease extension - 300mm (12") with 90° angle at end



NEEDLEPOINT COUPLER J BEND KZLNJ

Push-on needlepoint grease extension - 300mm (12") with J bend at end



NEEDLEPOINT COUPLER - 45° KZLN45

Push-on needlepoint grease extension - 300mm (12") with 45° angle at end



NEEDLEPOINT COUPLER - 12" KZLNS

Push-on needlepoint grease extension - 300mm (12")



NEEDLEPOINT COUPLER - 90° KZSNR

Push-on needlepoint grease extension - 110mm (4.25") with 90° angle at end to access different grease points

BATTERY OPERATED PUMP



BOP20 BATTERY OPERATED PUMP

Simple yet clever, the BOP is a portable, rechargeable, 18 volt battery operated oil pump, designed to improve workshop efficiency & reduce workshop fatigue inherent with operating manual oil pumps.



Easy portable Powerhead

Single Powerhead for multiple pump stems

Lithium-ion Battery and Charger

18V rechargeable 2.0Ah battery delivers up to 105L per charge

Drain back Adaptor

To drain back oil residue back to the drum

New modular concept

Sealed wetted parts for zero contamination

Adjustable suction tube



BP20S-OLA

BOP Inline Meter

Easy control nozzle

Simple single handed 'on demand' flow nozzle

½" x 1.5m hose (for all models except HV) and ¼" x 1.5m Transparent hose (HV models only)



BOP20 Starter Kit

Pump stem, Powerhead, hose & gun assembly, battery pack and charger.

BOP20 Pump Stem Kits

Pump stem, hose & gun assembly.

BOP Inline Meter

BOP Inline Meter, Fittings & Battery.

Service Parts

- BP-1K: Seal kit for Std BOP
- BP-2K: Seal Kit for HV and ATF
- BP-3K: Seal Kit for Coolant
- BP-HG: Gun and Hose Set
- BP20-AK: Bung Adaptor Kit suitable for BOP20 pump stems
- BP-HGHV: High Vis Gun and Hose Set
- BP077S: Nozzle dust cap

Applications:

Suitable for use in all industries to replace old style manual operated drum pumps

Part Number	BP20S-OLA	BP20S-OHA
Description	BOP20 Starter kit	High Viscosity BOP20 Starter Kit
Delivery rate*	Up to 3.5L/min**	Min 2L/min**
Oil Drum size	20L	20L
Hook colour	Black	Yellow
On demand flow control	✓	✓
Easy flow control nozzle	✓	✓
Portable Powerhead	✓	✓
Self-Priming	✓	✓
Safety lockout carry handle	✓	✓
Sealed Wetted parts	✓	✓
Compatible fluids	Suitable for Oils up to SAE75W90	Suitable for Heavy Oils up to SAE140
Rechargeable Battery	2.0Ah Li-Ion	2.0Ah Li-Ion
Charger	1hr fast	1hr fast
BOP Inline Meter	✓	✓

BOP60 BATTERY OPERATED PUMP

Simple yet clever, the BOP is a portable, rechargeable, 18 volt battery operated oil pump, designed to improve workshop efficiency & reduce workshop fatigue inherent with operating manual oil pumps.



Easy portable Powerhead

Single Powerhead for multiple pump stems

Lithium-ion Battery and Charger

18V rechargeable 2.0Ah battery delivers up to 105L per charge

Drain back Adaptor

To drain back oil residue back to the drum

New modular concept

Sealed wetted parts for zero contamination

Adjustable suction tube



BP60S-OLA

BOP Inline Meter

Easy control nozzle

Simple single handed 'on demand' flow nozzle

½" x 1.5m hose (for all models except HV) and ¼" x 1.5m Transparent hose (HV models only)



BOP60 Starter Kit

Pump stem, powerhead, hose & gun assembly, battery pack and charger.

BOP60 Pump Stem Kits

Pump stem, hose & gun assembly.

BOP Inline Meter

BOP Inline Meter, Fittings & Battery.

Service Parts

- BP-1K: Seal kit for Std BOP
- BP-2K: Seal Kit for HV and ATF
- BP-3K: Seal Kit for Coolant
- BP20-1K: Pump Seal Kit
- BP-HG: Gun and Hose Set
- BP60-AK: Bung Adaptor Kit suitable for BOP60 pump stems
- BP-HGHV: High Vis Gun and Hose Set
- BP077S: Nozzle dust cap

Applications:

Suitable for use in all industries to replace old style manual operated drum pumps

Part Number	BP60S-OLA	BP60S-OHA
Description	BOP60 Starter kit	High Viscosity BOP60 Starter Kit
Delivery rate*	Up to 3.5L/min**	Min 2L/min**
Oil Drum size	60L	60L
Hook colour	Black	Yellow
On demand flow control	✓	✓
Easy flow control nozzle	✓	✓
Easy portable Powerhead	✓	✓
Self-Priming	✓	✓
Safety lockout carry handle	✓	✓
Sealed Wetted parts	✓	✓
Compatible fluids	Suitable for Oils up to SAE75W90	Suitable for Heavy Oils up to SAE140
Rechargeable Battery	2.0Ah Li-Ion	2.0Ah Li-Ion
Charger	1hr fast	1hr fast
BOP Inline Meter	✓	✓

MANUAL OIL PUMPS

Hand operated oil pumps

The C7 is truly a multi-purpose gear oil pump with having a sliding bung adaptor fitted to allow multiple drum heights across the 15 to 25 litre containers. Delivers on the down-stroke (includes 3 different drum adapters).



10 YEARS
MACNAUGHT
WARRANTY

All purpose oil transfer pump

The MAOP20 All-Purpose 20L Oil Transfer Pump is designed for dispensing most service fluids including engine, gear, transmission, hydraulic and some engine coolants from 20L - 25L drums. An extendable suction tube and two additional bung adaptors ensure that the expanding range of different size and types of drums are easily catered for.



2 YEARS
MACNAUGHT
WARRANTY

	C7N-01 Oil pump	C7-01 Oil pump	C7Z-01 (Zinc) Oil pump	C7-51 Oil pump	MAOP20 Oil pump
Features	Gear oil pump	Gear oil pump with hose	UG Coal compatible gear oil pump with hose	Gear oil pump with ATF strainer and hose	Gear oil pump with pump extender
Pump output	100mL/stroke	100mL/stroke	100mL/stroke	100mL/stroke	75mL/stroke
Hose	X	1.8m rubber hose & non drip nozzle	1.8m rubber hose & non drip nozzle	1.8m rubber non drip nozzle	1.8 m oil resistant hose with non drip nozzle
Non drip nozzle	X	manual	manual	manual	automatic
Drum size	15L - 25L	15L - 25L	15L - 25L	15L - 25L	15L - 25L
Drum adapter	multiple sliding bung adapters				
Fully serviceable	✓	✓	✓	✓	X
Warranty¹	10 Years	10 Years	10 Years	10 Years	2 Years
Compatible fluids	kerosene, two stroke mix, lubricating oils to SAE140				

Note¹ Subject to Macnaught warranty terms and conditions

Hand operated oil pumps

A2H Multi-Purpose

A classic Macnaught hand pump, the A2H MULTI-PURPOSE Drum Pump is the ideal pump for transferring a wide variety of fluids such as diesel fuel, lubricating oils and an extensive range of non-corrosive fluids and chemicals.

C11 OIL PUMP

This pump is supplied complete with a 1.8m delivery hose, suitable for 60 – 205L drums. This equipment is fully repairable to provide a much longer service life.

C16 SUCTION GUN

The C16 is designed to transfer mineral oils in and out of gearboxes, transfer cases and differentials as well as evacuating sump oil out of an inboard marine engine.



10 YEARS
MACNAUGHT
WARRANTY

	A2H Multi-Purpose Lever Pump	C11-01 Lever Action Gear Oil Pump	C16-01 Suction Gun - 500ml
Pump output	250mL/stroke	75mL/stroke	500mL
Hose length	1.8m nozzle	1.8m	300mm
Non drip nozzle	X	manual	X
Drum size	60L - 205L	60L & 205L	X
Drum adapter	2" built in	2" sliding	X
Fully serviceable	✓	✓	✓
Compatible fluids	diesel, lubricating oils to SAE90 and other non-corrosive solvents. To determine liquid compatibility consult refer to compatibility chart www.macnaught.com	engine oil, gear oils to SAE140, auto trans and hydraulic fluid	mineral oils to SAE140
Warranty¹	10 years	10 years	10 years

Note¹ Subject to Macnaught warranty terms and conditions

Spring loaded pumps

These spring loaded oil pumps provide the means to automatically dispense engine and gear oils by simply pressing the oil gun trigger.

	S20H-01 Spring-Loaded Gear Oil Pump - 20L	S60H-01 Spring-Loaded Gear Oil Pump - 60L
Pump output	340mL/prime	500mL/prime
Hose	1.5m kink resistant hose	1.5m kink resistant hose
Dispense gun	✓	✓
Drum size	20L	60L
Drum bung	✓	✓
ATF filter	X	X
Fully serviceable	✓	✓
Compatible fluids	Engine oil, gear oils to SAE140, auto trans and hydraulic fluid	
Warranty¹	10 years	10 years

Note¹ Subject to Macnaught warranty terms and conditions



10 YEARS
MACNAUGHT
WARRANTY

AIR OPERATED OIL PUMPS - (T-series)



OILMASTER® T series ratio air operated oil stub pump

The OILMASTER range of ratio stub pumps are high quality, economically priced oil pumps. The ideal choice for small workshop or service truck applications. The 'T' Series range of pumps have been designed with a non-corrosive air motor requires that does not require any oil lubrication, the pumps have a very low air consumption and the noise levels during operation are very low. The 'T' series design includes a built in pressure relief valve to protect against pressure build up caused by thermal expansion suitable for oils and premix coolants up to SAE140 viscosity.



Value Proposition

The 'T' series air operated stub pumps are premium quality, reliable, economically priced oil pump. With the combination of low air consumption, quiet air motor operation.

Recommended Additional Offerings:

- Wall Bracket (TD20-Black)
- Feeder hose set - connect the pump to delivery nozzle or reel (TD-25K)
- 1/2" Retractable oil reel (OMP415B)
- Any of the HG series oil control guns can be used

Applications:

Automotive, Truck and Buses, Farming, Construction and Earthmoving, Military, Mining, Aircraft, Trains

OILMASTER® T-series air operated oil pumps



	T112S-01	T112T-01	T312S-01	T312T-01	T512S-01	T512T-01	T512-01-11
Pump ratio	1:1 ratio	1:1 ratio	3:1 ratio	3:1 ratio	5:1 ratio	5:1 ratio	5:1 ratio
Output SAE 10*	23L/min	23L/min	13L/min	13L/min	11L/min	11L/min	11L/min
Output SAE 15W-40*	22L/min	22L/min	12L/min	12L/min	10L/min	10L/min	10L/min
Output SAE 90*	21L/min	21L/min	11L/min	11L/min	9L/min	9L/min	9L/min
Pressure relief valve	X	X	✓	✓	✓	✓	✓
2" bung adapter	✓	✓	✓	✓	✓	✓	✓
Fully serviceable	✓	✓	✓	✓	✓	✓	✓
Warranty¹	10 Years	10 Years	10 Years	10 Years	10 Years	10 Years	10 Years
Compatible fluids	Engine and gear oils up to SAE90, auto trans, hydraulic fluid and anti-freeze / anti-boil		Engine and gear oils up to SAE140, auto trans, hydraulic fluid and anti-freeze / anti-boil				
Min-Max air pressure	400-1030kPa (60/150psi)	400-1030kPa (60/150psi)	400-1030kPa (60/150psi)	400-1030kPa (60/150psi)	400-1030kPa (60/150psi)	400-1030kPa (60/150psi)	400-1030kPa (60/150psi)
Min air compressor	0.3m ³ /min (10cfm)	0.3m ³ /min (10cfm)	0.15m ³ /min (5cfm)	0.15m ³ /min (5cfm)	0.15m ³ /min (5cfm)	0.15m ³ /min (5cfm)	0.15m ³ /min (5cfm)
Air inlet	1/4" NPT(F)	1/4" NPT(F)	1/4" NPT(F)	1/4" NPT(F)	1/4" NPT(F)	1/4" NPT(F)	1/4" NPT(F)
Pump outlet	3/4" BSP/NPT(F)	3/4" BSP(F)	3/4" BSP(F)/NPT(F)	3/4" BSP(F)	1/2" BSP/NPT(F)	1/2" BSP(F)	1/2" BSP(F)
Pump inlet	1" BSP (F) / 1" NPT (F)	Suction Tube	1" BSP (F) / 1" NPT (F)	Suction Tube	1" BSP (F) / 1" NPT (F)	Suction Tube	Suction Tube
NPT			T312-02	T312-02	T512-02	T512-02	

Note* Pump tested at 100psi c/w 1" PD meter. Note¹ Subject to Macnaught warranty terms and conditions

AIR OPERATED OIL DRUM PUMP PACKAGES



OILMASTER® 3:1 Oil Dispensing Kit

The T312THGE-01 pump kit includes a premium quality T312T-01 (3:1) ratio air-operated oil drum pump c/w 3m (10ft) x 1/2" (12.5mm) oil hose, HG20R-012E-01 electronic metered oil control gun with rigid extension and non-drip nozzle. The kit has an approximate flow rate 8L/min (2.1 US gal/min) with SAE10 oil and is suitable for oils up to SAE 140, pre-mix coolants.



HG20R-012E-01
Oil control gun with electronic meter, rigid extension and auto non-drip nozzle

2" Sliding bung adapter

Quiet Air Motor design
Meets all industry noise level standards. Doesn't require air-line lubricator

T312T-01 (3:1) Ratio oil pump
(No oil lubricator required)

TD-25K (1/2"x 3m)
oil hose with fittings

Suction tube to suit
205ltr container



Value Proposition

The T312THGE-01 pump kit includes a premium quality T312T-01 (3:1) ratio air-operated oil drum pump which has been designed with a non-corrosive air motor requires that does not require any oil lubrication. The premium quality oil control gun with electronic meter and 3m (10ft) long oil hose completes the kit which will give long reliable service and peace of mind. The kit will deliver flowrates up to 8 ltr/min (2.1 US gal/min).

Package Includes:

- T312T-01 (3:1) ratio oil pump (205ltr)
- HG20R-012E-01 Oil control gun with electronic meter and automatic non-drip nozzle
- TD-25K 1/2"x 3m oil hose with fittings
- Instruction manual

Applications:

Automotive, Truck & Buses, Farming, Construction & Earthmoving, Military, Mining, Aircraft, Trains, Manufacturing, Mining, Aircraft, Trains, Manufacturing

Drum based oil dispensing systems



Part Number	T112THG-01	T112THGE-01	T312THG-01	T312THGE-01	T512THG-01	T512THGE-01
Description	1:1 Ratio Oil Pump Kit with Hose and Unmetered Gun	1:1 Ratio Oil Pump Kit with Hose and Metered Gun	3:1 Ratio Oil Pump Kit with Hose and Unmetered Gun	3:1 Ratio Oil Pump Kit with Hose and Metered Gun	5:1 Ratio Oil Pump Kit with Hose and Unmetered Gun	5:1 Ratio Oil Pump Kit with Hose and Metered Gun
Pump ratio	1:1 ratio	1:1 ratio	3:1 ratio	3:1 ratio	5:1 ratio	5:1 ratio
Pump	T112T-01	T112T-01	T312T-01	T312T-01	T312T-01	T312T-01
Outlet hose length	3m (10ft) x 19mm (3/4")	3m (10ft) x 19mm (3/4")	3m (10ft) x 12mm (1/2")	3m (10ft) x 12mm (1/2")	3m (10ft) x 12mm (1/2")	3m (10ft) x 12mm (1/2")
Oil control gun	HG20R-01	HG20R-012E-01	HG20R-01	HG20R-012E-01	HG20R-01	HG20R-012E-01
Output SAE10*	10L/min (2.6gal/min)	10L/min (2.6gal/min)	8L/min (2.1gal/min)	8L/min (2.1gal/min)	8L/min (2.1gal/min)	8L/min (2.1gal/min)
Output 15W-40*	8.5 L/min (2.2gal/min)	8.5 L/min (2.2gal/min)	7 L/min (1.8gal/min)	7 L/min (1.8gal/min)	7 L/min (1.8gal/min)	7 L/min (1.8gal/min)
Output SAE140*	7 L/min (1.8gal/min)	7 L/min (1.8gal/min)	6 L/min (1.6gal/min)	6 L/min (1.6gal/min)	6 L/min (1.6gal/min)	6 L/min (1.6gal/min)
Container	205L (55gal) drum	205L (55gal) drum	205L (55gal) drum	205L (55gal) drum	205L (55gal) drum	205L (55gal) drum
Airline lubricator	Not required	Not required	Not required	Not required	Not required	Not required
Pressure relief valve	✓	✓	✓	✓	✓	✓
2" bung adaptor	✓	✓	✓	✓	✓	✓
Compatible fluids	Engine and gear oils up to SAE90, auto trans, hydraulic fluid and anti-freeze / anti-boil		Engine and gear oils up to SAE140, auto trans, hydraulic fluid and anti-freeze / anti-boil		Engine and gear oils up to XXXXXXX, auto trans, hydraulic fluid and anti-freeze / anti-boil	
Max air pressure	1030kPa (150psi)	1030kPa (150psi)	1030kPa (150psi)	1030kPa (150psi)	1030kPa (150psi)	1030kPa (150psi)
Min air pressure	400kPa (60psi)	400kPa (60psi)	400kPa (60psi)	400kPa (60psi)	400kPa (60psi)	400kPa (60psi)
Min air compressor	0.3m ³ /min (10cfm)	0.3m ³ /min (10cfm)	0.15m ³ /min (5cfm)	0.15m ³ /min (5cfm)	0.15m ³ /min (5cfm)	0.15m ³ /min (5cfm)
Air inlet	1/4" NPT (F)	1/4" NPT (F)	1/4" NPT (F)	1/4" NPT (F)	1/4" NPT (F)	1/4" NPT (F)

Note* Pump tested at 100psi c/w HG55 oil control gun. Note* Subject to Macnaught warranty terms and conditions
Please Note: future models may utilise alternative suction tube than that shown.

AIR OPERATED OIL PUMPS - (R-series)



'R' series air operated ratio oil pump

The 'R' Series range of pumps have been designed and manufactured using a strong metal construction, providing maximum performance and long service life. All the 'R' Series pumps are supplied complete with an inline lubricator to help prevent premature wear. Suitable for oils up to SAE140 viscosity and premix coolants. The ideal choice for remote mount or integration into lubrication systems.



Long service life
Supplied with In-line lubricator to prevent excess wear and extend service life

Air inlet (1/4"NPT)

Robust and Durable Design
Heavy duty aluminium and steel air motor construction

Sliding bung adaptor (2"BSP)
For all R-Series pump models



Maximize Performance life
Large exhaust ports integrated to prevent icing

Heavy duty construction
For long reliable service life

Oil outlet (3/4"BSPT or NPT)
For all R-Series pump models

Pressure relief valve
On 5:1 ratio pumps only

Oil inlet (1"BSPT or NPT)
On all stub pump models

- Service Parts**
- R100-1K: R100 Major Service Kit
 - R100-2K: R100 Seal Kit
 - ST003AS: Suction Tube Set

- Service Parts**
- R300-2K: R300 Major Service Kit
 - R300-3K: R300 Seal Kit
 - ST003AS: Suction Tube Set

- Service Parts**
- R500-2K: R500 Major Service Kit
 - R500-3K: R500 Seal Kit
 - ST003AS: Suction Tube Set

- Service Parts**
- R1000-1K: R1000 Major Service Kit
 - R1000-2K: R1000 Seal Kit
 - ST003AS: Suction Tube Set

Value Proposition

The R series pumps are high quality, heavy duty, reliable oil pumps. The ideal choice for remote mount or integration into oil systems. The strong metal construction, provides maximum performance and long service life.

Applications:

Automotive, Truck and Buses, Farming, Construction and Earthmoving, Military, Mining, Aircraft, Trains

Drum based oil dispensing systems



Part Number (BSP Models)	R100T-01	R300S-01	R300T-01	R500S-01	R500T-01	R1000S-01	R1000T-01
Description	Drum Pump	Stub Pump	Drum Pump	Stub Pump	Drum Pump	Stub Pump	Drum Pump
Pump ratio	1:1 ratio	3:1 ratio	3:1 ratio	5:1 ratio	5:1 ratio	10:1 ratio	10:1 ratio
Output SAE 10*	60L/min (16gal/min)	23L/min (6gal/min)	23L/min (6gal/min)	32L/min (8.5gal/min)	32L/min (8.5gal/min)	18L/min (4.8gal/min)	18L/min (4.8gal/min)
Output SAE 15W-40*	45L/min (12gal/min)	19L/min (5gal/min)	19L/min (5gal/min)	30L/min (8gal/min)	30L/min (8gal/min)	17L/min (4.5gal/min)	17L/min (4.5gal/min)
Output SAE90*	43L/min (11.3gal/min)	18L/min (4.8gal/min)	18L/min (4.8gal/min)	28L/min (7.3gal/min)	28L/min (7.3gal/min)	15L/min (4gal/min)	15L/min (4gal/min)
Airline lubricator	✓	✓	✓	✓	✓	✓	✓
Pressure relief valve	x	x	x	✓	✓	x	x
2" bung adaptor	✓	✓	✓	✓	✓	✓	✓
Compatible fluids	Engine and gear oils up to SAE90(R100T) and SAE140(all other models), auto trans and hydraulic fluid, diesel						
Min-Max air pressure	400-1030kPa (60/150psi)	400-1030kPa (60/150psi)	400-1030kPa (60/150psi)	400-1030kPa (60/150psi)	400-1030kPa (60/150psi)	400-1030kPa (60/150psi)	400-1030kPa (60/150psi)
Air inlet	1/4" NPT(F)	1/4" NPT(F)	1/4" NPT(F)	1/4" NPT(F)	1/4" NPT(F)	1/4" NPT(F)	1/4" NPT(F)
Pump outlet	3/4" BSP(F) / 3/4" NPT (F)	3/4" BSP(F) / 3/4" NPT (F)	3/4" BSP(F) / 3/4" NPT (F)	3/4" BSP(F) / 3/4" NPT (F)	3/4" BSP(F) / 3/4" NPT (F)	3/4" BSP(F) / 3/4" NPT (F)	3/4" BSP(F) / 3/4" NPT (F)
Pump inlet	Suction Tube	1" BSP(F) / 1" NPT (F)	Suction Tube	1" BSP(F) / 1" NPT (F)	Suction Tube	1" BSP(F) / 1" NPT (F)	Suction Tube
Min air compressor	0.22m ³ /min (8cfm)	0.16m ³ /min (6cfm)	0.16m ³ /min (6cfm)	0.3m ³ /min (10cfm)	0.3m ³ /min (10cfm)	0.5m ³ /min (18cfm)	0.5m ³ /min (18cfm)
NPT Models	R100T-02	R300S-02	R300T-02	R500S-02		R1000S-02	

Note* Pump tested at 100psi c/w 1" PD meter. Note¹ Subject to Macnaught warranty terms and conditions

AIR OPERATED OIL DRUM PUMP PACKAGES

'R' series 3:1 ratio oil dispensing kit (with electronic metered oil gun)

The R300THGE-01 pump kit includes a premium quality R300T-01 (3:1) air-operated oil drum pump, c/w 3m (10ft) x 1/2" (12.5mm) oil hose, HG20R-012E-01 electronic metered oil control gun, rigid extension and non-drip nozzle. The kit has an approximate flow rate 12L/min (3 US gal/min) with SAE10 oil and is suitable for oils up to SAE 140, pre-mix coolants.

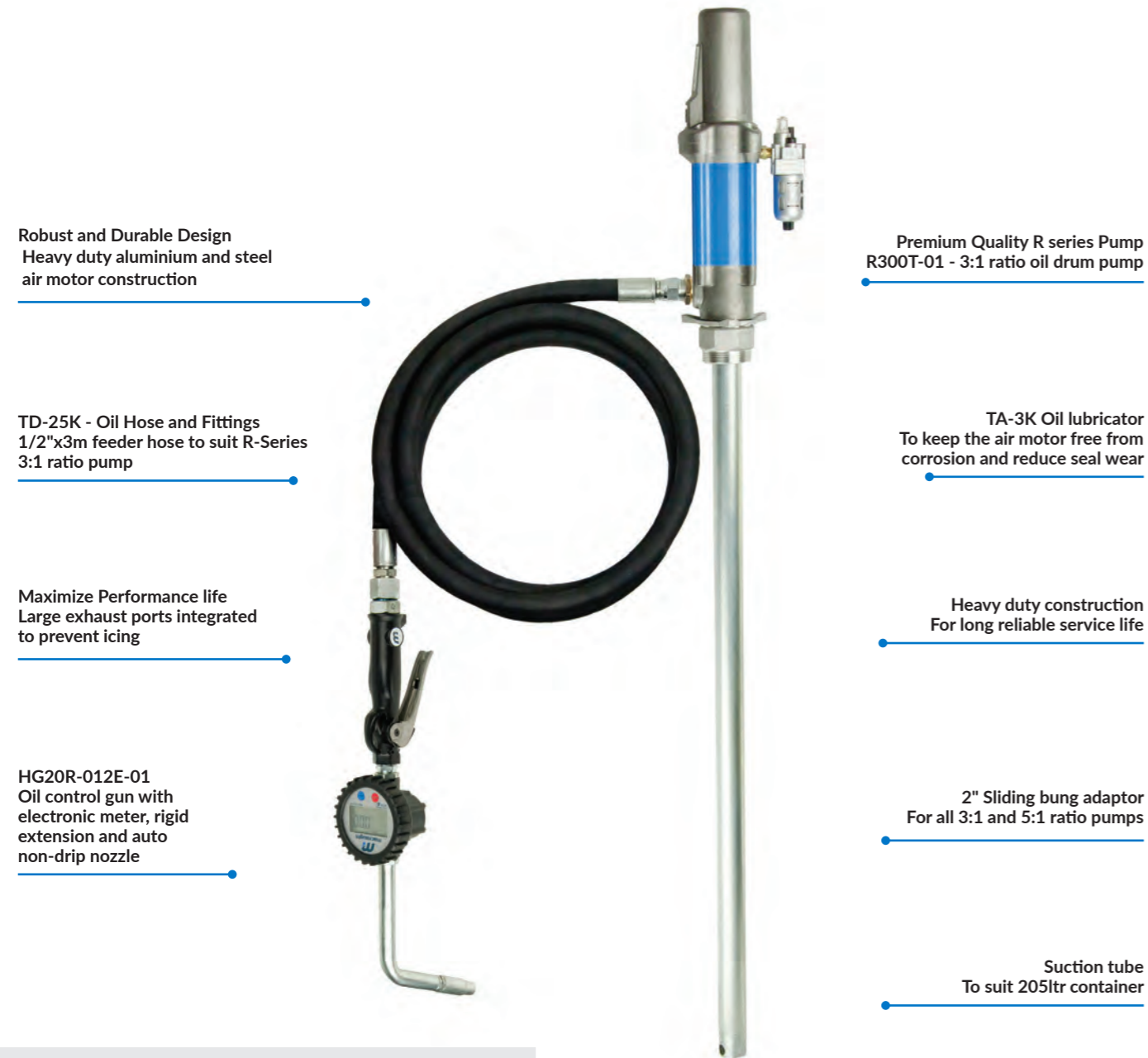

Robust and Durable Design
Heavy duty aluminium and steel air motor construction

TD-25K - Oil Hose and Fittings
1/2"x3m feeder hose to suit R-Series 3:1 ratio pump

Maximize Performance life
Large exhaust ports integrated to prevent icing

HG20R-012E-01
Oil control gun with electronic meter, rigid extension and auto non-drip nozzle

Premium Quality R series Pump
R300T-01 - 3:1 ratio oil drum pump

TA-3K Oil lubricator
To keep the air motor free from corrosion and reduce seal wear

Heavy duty construction
For long reliable service life

2" Sliding bung adaptor
For all 3:1 and 5:1 ratio pumps

Suction tube
To suit 205ltr container

Package Includes:

- R300T-01 (3:1) ratio oil pump (205ltr)
- HG20R-012E-01 Oil control gun with electronic meter and automatic non-drip nozzle
- TD-25K 1/2"x 3m oil hose with fittings
- 2" Bung adaptor
- Instruction manual

Recommended Additional Offerings:

- MOS1220-01 (1/2"x 20m) oil reel
- R300-2K Major Service kit
- R300-3K Seal kit

Applications:

Automotive, Truck and Buses, Farming, Construction and Earthmoving, Military, Mining, Aircraft, Trains

Drum based oil dispensing systems



Part Number	R100THG-01	R100THGE-01	R300THG-01	R300THGE-01
Description	1:1 Ratio Oil Pump Kit with Hose and Unmetered Gun	1:1 Ratio Oil Pump Kit with Hose and Metered Gun	3:1 Ratio Oil Pump Kit with Hose and Unmetered Gun	3:1 Ratio Oil Pump Kit with Hose and Metered Gun
Pump ratio	1:1 ratio	1:1 ratio	3:1 ratio	3:1 ratio
Pump	R100T-01	R100T-01	R300T-01	R300T-01
Outlet hose length	3m (10ft) x 19mm (3/4")	3m (10ft) x 19mm (3/4")	3m (10ft) x 12mm (1/2")	3m (10ft) x 12mm (1/2")
Oil control gun	HG20R-01	HG20R-012E-01	HG20R-01	HG20R-012E-01
Output SAE10*	12L/min (3.1gal/min)	12L/min (3.1gal/min)	12L/min (3.1gal/min)	12L/min (3.1gal/min)
Output 15W-40*	9L/min (2.4gal/min)	9L/min (2.4gal/min)	9L/min (2.4gal/min)	9L/min (2.4gal/min)
Output SAE140*	8L/min (2.1gal/min)	8L/min (2.1gal/min)	8L/min (2.1gal/min)	8L/min (2.1gal/min)
Container	205L (55gal) drum	205L (55gal) drum	205L (55gal) drum	205L (55gal) drum
Airline lubricator	✓	✓	✓	✓
2" bung adaptor	✓	✓	✓	✓
Compatible fluids	Oils up to SAE90 (1:1 pumps) and SAE140 (3:1 pumps), automatic trans fluid, engine oil, gear oil, hydraulic oil, diesel, kerosene, anti-freeze/anti-boil			
Max air pressure	1030kPa (150psi)	1030kPa (150psi)	1030kPa (150psi)	1030kPa (150psi)
Min air pressure	400kPa (60psi)	400kPa (60psi)	400kPa (60psi)	400kPa (60psi)
Min air compressor	0.22m ³ /min (8cfm)	0.22m ³ /min (8cfm)	0.16m ³ /min (6cfm)	0.16m ³ /min (6cfm)
Air inlet	1/4" NPT (F)	1/4" NPT (F)	1/4" NPT (F)	1/4" NPT (F)

Note* Pump tested at 100psi c/w HG55 oil control gun. Note¹ Subject to Macnaught warranty terms and conditions

AIR OPERATED OIL DRUM PUMP PACKAGES



R-Series Trolley Based Oil Dispensing Systems

The IBC or POD Mounted Oil Dispensing System uses either a R series or T series ratio oil pump, capable of handling a wide range of viscosity fluids. It comes supplied with a solid hot dipped galvanised base frame, 3:1 or 5:1 ratio oil pump, heavy duty 1/2" x 10m or 15m oil reel, with an option of metered or non metered oil control gun with holster and complete kit with all fittings and hoses.



Trolley Based Oil Dispensing Systems



Part Number	OS100G-01	OS100GE-01	OS100T-01	OS100TE-01	OS100S-01	OS100SE-01
Description	3:1 R-Series Pump with Retracts reel, Trolley and Unmetered Gun	3:1 R-Series Pump with Retracts reel, Trolley and Metered Gun	3:1 R-Series Pump with Trolley and Unmetered Gun	3:1 R-Series Pump with Trolley and Metered Gun	3:1 R-Series Pump with Retracts Reel and Unmetered Gun	3:1 R-Series Pump with Retracts Reel and Metered Gun
Part Number - Without Gun	OS100B-01		X	X	X	X
Pump ratio	3:1 ratio	3:1 ratio	3:1 ratio	3:1 ratio	3:1 ratio	3:1 ratio
Pump	R300S-01	R300S-01	R300S-01	R300S-01	R300T-01	R300T-01
Oil Control Gun	HG20R-01	HG20R-012E-01	HG20R-01	HG20R-012E-01	HG20R-01	HG20R-012E-01
Outlet hose length/reel	Retracts OMP415B - 15m x 12.5mm oil hose	Retracts OMP415B - 15m x 12.5mm oil hose	X	X	Retracts OMP415B - 15m x 12.5mm oil hose	Retracts OMP415B - 15m x 12.5mm oil hose
Trolley	TR205	TR205	TR205	TR205	X	X
Output SAE10*	11L/min (2.9gal/min)	11L/min (2.9gal/min)	11L/min (2.9gal/min)	11L/min (2.9gal/min)	11L/min (2.9gal/min)	11L/min (2.9gal/min)
Output 15W-40*	9L/min (2.4gal/min)	9L/min (2.4gal/min)	9L/min (2.4gal/min)	9L/min (2.4gal/min)	9L/min (2.4gal/min)	9L/min (2.4gal/min)
Output SAE80W-90*	5L/min (1.3gal/min)	5L/min (1.3gal/min)	5L/min (1.3gal/min)	5L/min (1.3gal/min)	5L/min (1.3gal/min)	5L/min (1.3gal/min)
Container	205L (55gal) drum	205L (55gal) drum	205L (55gal) drum	205L (55gal) drum	205L (55gal) drum	205L (55gal) drum
Airline lubricator	✓	✓	✓	✓	✓	✓
Pressure relief valve	Built in	Built in	Built in	Built in	Built in	Built in
2" bung adaptor	✓	✓	✓	✓	✓	✓
Compatible fluids	Oils up to SAE140 including automatic transmission fluid, engine oil, gear oil, hydraulic oil, diesel, kerosene and anti-freeze/anti-boil					

Kit Parts:

- TR205 Trolley (available only with following kits: OS100G-01, OS100GE-01, OS100B-01, OS100T-01 and OS100TE-01)
- R300S-01 Oil pump
- OMP415B-01 Oil reel (available only with following kits: OS100G-01, OS100B-01, OS100S-01 and OS100SE-01)
- HG20R-012E-01 Electronic oil gun (available only with following kits: OS100GE-01, OS100TE-01 and OS100SE-01)
- HG20R-01 Rigid Extension oil gun (available only with following kits: OS100G-01, OS100T-01 and OS100S-01)
- Includes all fittings

AIR OPERATED OIL DRUM PUMP PACKAGES



Portable trolley oil dispensing systems

This Premium quality portable trolley based oil systems designed suit 205L oil drums. The systems include metered or non metered oil control gun, OMP415B 1/2"x 15m) oil reel 3:1 ratio air operated oil pump ('T' series or 'R' series) and a 250ltr drum trolley complete with all fittings and hoses. This quality oil system has been designed and manufactured to give you many years of reliable trouble free service.



Drum based oil dispensing systems



Part Number	OS50G-01	OS50GE-01	OS50T-01	OS50TE-01	OS50S-01	OS50SE-01
Description	3:1 T-Series Pump with Retractable reel, Trolley and Unmetered Gun	3:1 T-Series Pump with Retractable reel, Trolley and Metered Gun	3:1 T-Series Pump with Trolley and Unmetered Gun	3:1 T-Series Pump with Trolley and Metered Gun	3:1 T-Series Pump with Retractable Reel and Unmetered Gun	3:1 T-Series Pump with Retractable Reel and Metered Gun
Part Number - Without Gun	OS50B-01		X	X	X	X
Pump ratio	3:1 ratio	3:1 ratio	3:1 ratio	3:1 ratio	3:1 ratio	3:1 ratio
Pump	T312T-01	T312T-01	T312T-01	T312T-01	T312T-01	T312T-01
Oil Control Gun	HG20R-01	HG20R-012E-01	HG20R-01	HG20R-012E-01	HG20R-01	HG20R-012E-01
Outlet hose length/ reel	Retracta OMP415B - 15m x 12.5mm oil hose	Retracta OMP415B - 15m x 12.5mm oil hose	X	X	Retracta OMP415B - 15m x 12.5mm oil hose	Retracta OMP415B - 15m x 12.5mm oil hose
Trolley	TR205	TR205	TR205	TR205	X	X
Output SAE10*	7L/min (1.8gal/min)	7L/min (1.8gal/min)	7L/min (1.8gal/min)	7L/min (1.8gal/min)	7L/min (1.8gal/min)	7L/min (1.8gal/min)
Output 15W-40*	6L/min (1.6gal/min)	6L/min (1.6gal/min)	6L/min (1.6gal/min)	6L/min (1.6gal/min)	6L/min (1.6gal/min)	6L/min (1.6gal/min)
Output SAE 80W-90*	5L/min (1.3gal/min)	5L/min (1.3gal/min)	5L/min (1.3gal/min)	5L/min (1.3gal/min)	5L/min (1.3gal/min)	5L/min (1.3gal/min)
Container	205L (55gal) drum	205L (55gal) drum	205L (55gal) drum	205L (55gal) drum	205L (55gal) drum	205L (55gal) drum
Airline lubricator	Not required	Not required	Not required	Not required	Not required	Not required
Pressure relief valve	Built In	Built In	Built In	Built In	Built In	Built In
2" bung adaptor	✓	✓	✓	✓	✓	✓

Package Includes:

- TR205 Trolley
- R300S-01 Oil pump
- OMP415B-01 Oil reel
- HG20R-012E-01 Electronic oil gun
- Includes all fittings

Applications:

Automotive, Truck and Buses, Farming Equipment, Textile Machinery, Construction and Earthmoving, Forklifts, Military Equipment (e.g. tanks, armoured vehicles) Mining Machinery, Aircraft, Trains

Note* Pump tested at 100psi c/w HG55 oil control gun. Note! Subject to Macnaught warranty terms and conditions

AIR OPERATED OIL - IBC/WALL MOUNT PKGS



IBC OR POD MOUNTED OIL DISPENSING SYSTEM (WITH HG20R-012E-01 OIL CONTROL GUN)

The IBC or POD Mounted Oil Dispensing System uses either a R series or T series ratio oil pump, capable of handling a wide range of viscosity fluids. It comes supplied with a solid hot dipped galvanised base frame, 3:1 or 5:1 ratio oil pump, heavy duty 1/2" x 10m or 15m oil reel, with an option of metered or non metered oil control gun with holster and complete kit with all fittings and hoses.

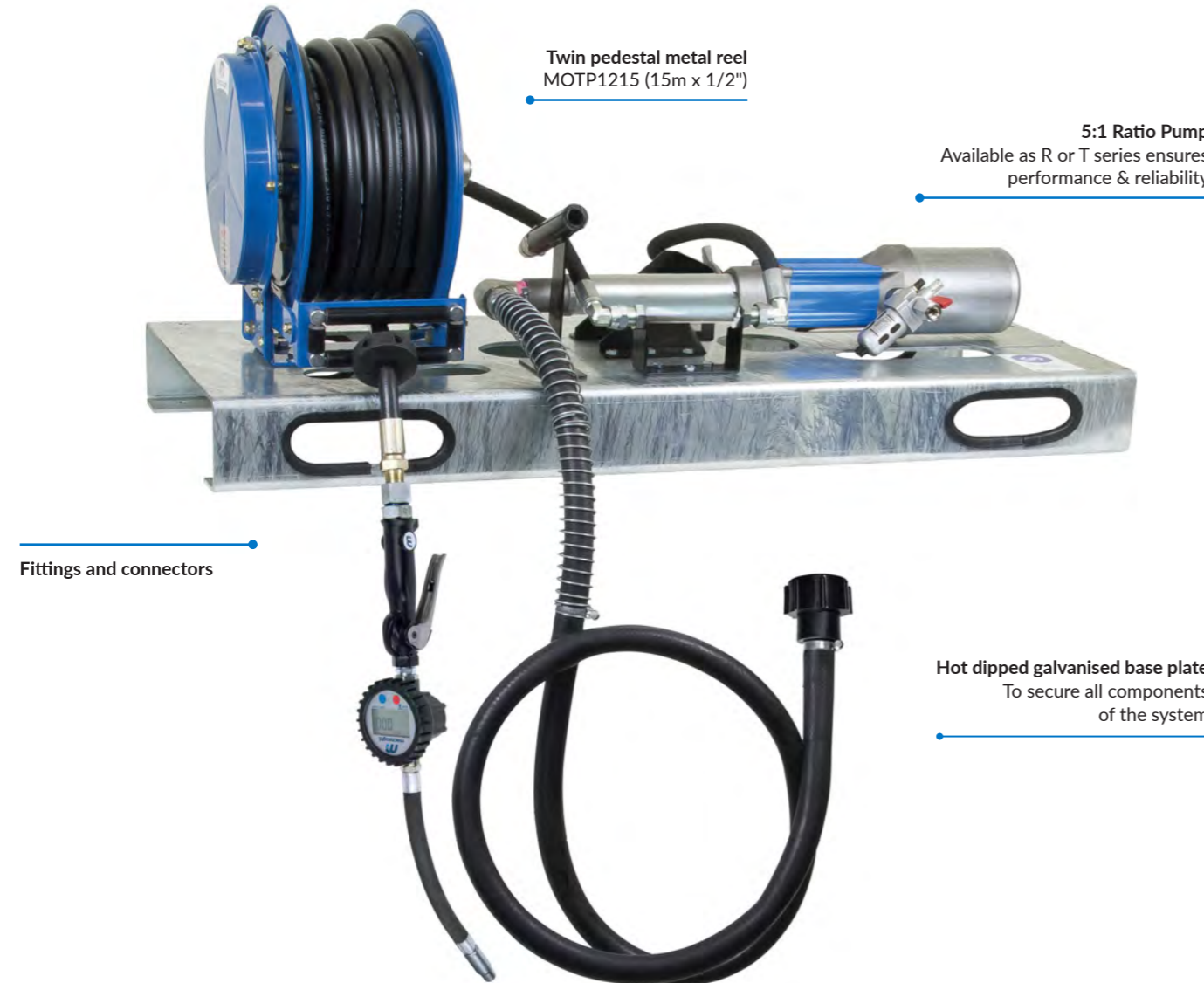

Twin pedestal metal reel MOTP1215 (15m x 1/2")

5:1 Ratio Pump Available as R or T series ensures performance & reliability

Fittings and connectors

Hot dipped galvanised base plate To secure all components of the system

R-Series pump model shown

Features & Benefits

Using the OILMASTER pump this kit is designed to be top-mounted on IBC's and is capable of handling a wide range of viscosities.

- Solid hot-drip galvanised base frame
- 'R' or 'T' series
- Heavy-duty, twin-pedestal oil reel - 15m x 1/2" hose
- HG20 metered or non metered oil control gun & holster
- All connecting fittings, hoses, breather and couplers

Value Proposition

This premium quality IBC oil dispensing system provides a complete dispensing system in one neat package.

Technical Specifications:

- 5:1 ratio oil pump
- 15m x 1/2" twin pedestal oil reel
- metered oil control gun
- gun holder
- all fittings included

Applications:

Truck and buses, constructions earthmoving, large oil transfer applications.

IBC OR POD MOUNTED OIL DISPENSING SYSTEMS



OS950IM-01

Also available with T-Series pumps



Part Number	OS900G-01	OS900GE-01	OS900IM-01	OS950G-01	OS950GE-01	OS950IM-01
Description	System with T-Series 5:1 pump, reel and un-metered gun	System with T-Series 5:1 pump, reel and metered gun	System with T-Series 5:1 pump, reel and in-line meter	System with R-Series 5:1 pump, reel and un-metered gun	System with R-Series 5:1 pump, reel and metered gun	System with R-Series 5:1 pump, reel and in-line meter
Part Number without Gun	OS900-01 (System with T series 5:1 Pump and Reel)			OS950-01 (System with R Series 5:1 Pump and Reel)		
Pump ratio	5:1 ratio	5:1 ratio	5:1 ratio	5:1 ratio	5:1 ratio	5:1 ratio
Pump	T512S-01	T512S-01	T512S-01	R500S-01	R500S-01	R500S-01
Hose reel length	15m (50ft)	15m (50ft)	15m (50ft)	15m (50ft)	15m (50ft)	15m (50ft)
Oil control gun	HG20R-01	HG20R-012E-01	HG20R-01	HG20R-01	HG20R-012E-01	HG20R-01
In-Line Meter	None	None	IM012E-01	None	None	IM012E-01
Output SAE10*	8L/min (2.1gal/min)	8L/min (2.1gal/min)	8L/min (2.1gal/min)	12L/min (3.1gal/min)	12L/min (3.1gal/min)	12L/min (3.1gal/min)
Output 15W-40*	7L/min (1.8gal/min)	7L/min (1.8gal/min)	7L/min (1.8gal/min)	10L/min (2.6gal/min)	10L/min (2.6gal/min)	10L/min (2.6gal/min)
Output SAE140*	6L/min (1.6gal/min)	6L/min (1.6gal/min)	6L/min (1.6gal/min)	8L/min (2.1gal/min)	8L/min (2.1gal/min)	8L/min (2.1gal/min)
Container	1000L (264gal) IBC	1000L (264gal) IBC	1000L (264gal) IBC	1000L (264gal) IBC	1000L (264gal) IBC	1000L (264gal) IBC
Airline lubricator	Not required	Not required	Not required	✓	✓	✓
Pressure relief valve	Built in	Built in	Built in	Built in	Built in	Built in
2" bung adaptor	✓	✓	✓	✓	✓	✓
Compatible fluids	Oils up to SAE140, automatic trans fluid, engine oil, gear oil, and hydraulic oil, diesel, kerosene, anti-freeze/anti-boil					



OIL FEEDER HOSE 5:1 RATIO TB-20K

Feeder hose - 3.0m x 12.5mm i.d. - 6900kPa (1000psi). 3/4" BSP (M) swivel x 1/2" BSP (M) fitting with 3/4" reducer. Suitable for R-SERIES™ and OILMASTER® in 5:1 and 10:1 ratio pumps



OIL FEEDER HOSE 3:1 RATIO TD-25K

Feeder hose - 3.0m x 12.5mm i.d. - 2,800kPa (400psi). 3/4" BSP (M) swivel x 1/2" BSP (M) fitting with 3/4" reducer. Suitable for R-SERIES™ and OILMASTER® in 3:1 ratio pumps



TELESCOPIC SUCTION TUBE TB25S



AIR OPERATED OIL - IBC SYSTEMS



IBC OR POD MOUNTED OIL DISPENSING SYSTEM

The IBC or POD Mounted Oil Dispensing System uses either a R series or T series ratio oil pump, capable of handling a wide range of viscosity fluids. It comes supplied with a powder coated steel mounting plate, 3:1 or 5:1 ratio oil pump, heavy duty 1/2" x 10m or 15m oil reel, with an option of metered or non metered oil control gun with holster and complete kit with all fittings and hoses.



3:1 T Series Pump
T312T-01 model provides high quality, durable, efficient and economical proposition

Premium Quality Retracta R3 Reel
OMP415B-01 Oil Reel comes with 15m x 1/2" oil hose

Feeder hose
1/2"x1m single wire braided feeder hose with suction spear and fittings

Wall Mount Plate
This heavy duty kit can be mounted or directly attached to an IBC or Bulk tank

OS400G-01



Why choose this product?

This premium quality IBC oil dispensing system provides a complete dispensing system in one neat package.

Applications:

Truck and buses, constructions earthmoving, large oil transfer applications.

Kit Parts:

- 3:1 Ratio T-Series Oil Pump
- HG20R-012E-01 Electronic oil gun (available on following kits: OS400TE-01)
- HG20R-01 Rigid Extension oil gun (available on following kits: OS400G-01 and OS400T-01)
- OMP415B-01 15m x 1/2" Oil Reel (available on following kits: OS400G-01, OS400B-01 and OS500B-01)
- Includes all fittings

IBC or pod mounted oil dispensing systems



OS400B-01

OS400T-01

Part Number	OS400G-01	OS400B-01	OS450B-01	OS400T-01	OS400TE-01	OS500B-01
Description	IBC/Pod Mounted 3:1 T-SERIES Pump, with Reel and Unmetered Gun	IBC/Pod Mounted 3:1 T-SERIES Pump with reel without Gun	IBC/Pod Mounted 3:1 T-SERIES Pump with reel without Gun	IBC/Pod Mounted 3:1 T-SERIES Pump with Unmetered Gun without Reel	IBC/Pod Mounted 3:1 T-SERIES Pump with Metered Gun without Reel	IBC/Pod Mounted 3:1 R-SERIES Pump with Reel and without Gun
Pump ratio	3:1 ratio	3:1 ratio	3:1 ratio	3:1 ratio	3:1 ratio	3:1 ratio
Pump	T312S-01	T312S-01	T312S-01	T312S-01	T312S-01	R300S-01
Oil Control Gun	HG20R-01	X	X	HG20R-01	HG20R-012E-01	X
Outlet hose length/reel	Retracta OMP415B - 15mx1/2"	Retracta OMP415B - 15mx1/2"	Retracta OMP415B - 15mx1/2"	6m x1/2" Hose	6m x1/2" Hose	Retracta OMP415B - 15mx1/2"
Output SAE10*	8L/min (2.1gal/min)	8L/min (2.1gal/min)	8L/min (2.1gal/min)	8L/min (2.1gal/min)	8L/min (2.1gal/min)	12L/min (3.1gal/min)
Output 15W-40*	7L/min (1.8gal/min)	7L/min (1.8gal/min)	7L/min (1.8gal/min)	7L/min (1.8gal/min)	7L/min (1.8gal/min)	9L/min (2.4gal/min)
Output SAE80W-90*	5L/min (1.3gal/min)	5L/min (1.3gal/min)	5L/min (1.3gal/min)	5L/min (1.3gal/min)	5L/min (1.3gal/min)	8L/min (2.1gal/min)
Container	1000L (264gal) IBC	1000L (264gal) IBC	1000L (264gal) IBC	1000L (264gal) IBC	1000L (264gal) IBC	1000L (264gal) IBC
Airline lubricator	Not required	Not required	Not required	Not required	Not required	✓
Pressure relief valve	Built In	Built In	Built In	Built In	Built In	X
2" bung adaptor	✓	✓	✓	✓	✓	✓
Compatible fluids	Oils up to SAE140, automatic trans fluid, engine oil, gear oil, and hydraulic oil, diesel, kerosene, anti-freeze/anti-boil					
Min/Max Air Pressure	400kPa (60psi) - 1030kPa (150psi)					

Recommended to be used with:

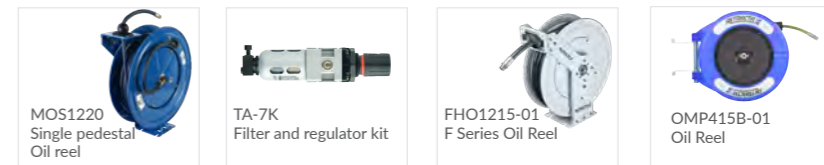

OIL CONTROL GUNS

Non-Metered Oil Control Guns

The Reliable HG20 oil gun is ideal for all types of workshops and automotive dealership applications. The HG20 is designed with a trigger lock on the handle and is supplied complete with flexible extension and automatic non drip nozzle.

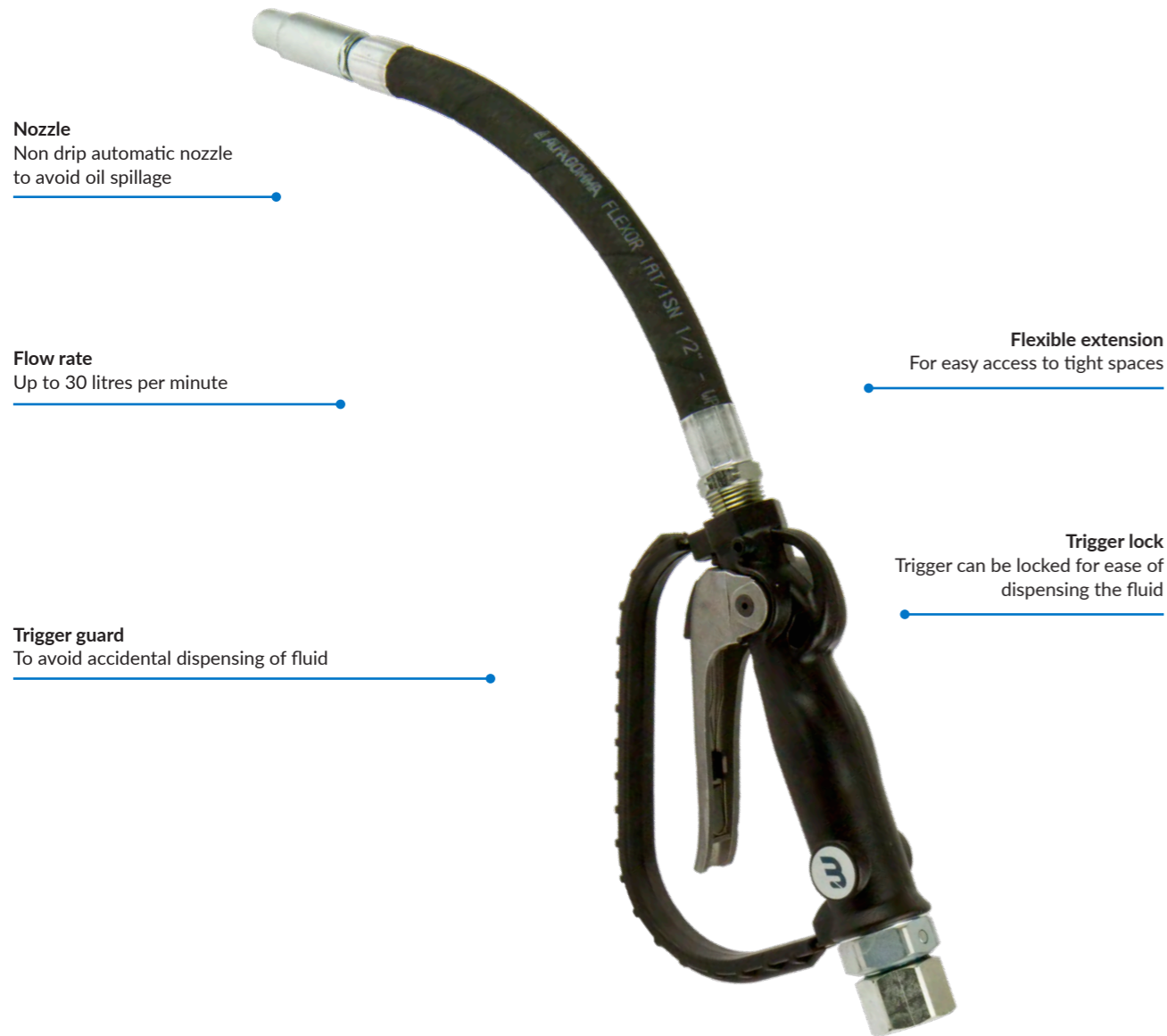

Nozzle
Non drip automatic nozzle to avoid oil spillage

Flow rate
Up to 30 litres per minute

Trigger guard
To avoid accidental dispensing of fluid

Flexible extension
For easy access to tight spaces

Trigger lock
Trigger can be locked for ease of dispensing the fluid

HG20F-01

Why choose this product?

Peace of mind reliability.

Package Includes:

- HG20 oil control gun
- Flexible Extension
- Automatic non-drip nozzle

Service Parts

- HG20-1K: Gun Seal Kit

Applications:

Suitable for use in most oil dispensing systems

NON-METERED CONTROL GUNS



HG20R-01

HG20F-01

CCG-01

Part Number (BSP models)	HG20R-01	HG20F-01	CCG-01
Description	Rigid Extension	Flexible Extension	Coolant Control Gun
Flow range	Up to 30L/min (8gal/min)	Up to 30L/min (8gal/min)	Up to 30L/min (8gal/min)
Inlet swivel	1/2" BSP(F)	1/2" BSP (F)	1/2" BSP inlet with 3/8" BSP adaptor
Non drip nozzle	✓	✓	✗
Latching trigger	✓	✓	✓
Fully serviceable	✓	✓	✗
Compatible fluids	Engine and gear oils up to SAE140, auto trans, hydraulic fluid, diesel, premix coolant (max 50%)		Coolant
Max working pressure	6900kPa (1000psi)	6900kPa (1000psi)	2500kPa (365psi)
Max working temp	70°C (158°F)	70°C (158°F)	70°C (158°F)
Wetted Materials	Acetal, Aluminium, Steel, Nitrile rubber		
Weight	0.8kg (1.8lb)	0.8kg (1.8lb)	0.8kg (1.8lb)
Extension type	Rigid	Flexible	Rigid
NPT Models	HG20R-02	HG20F-02	

Recommended to be used with:



CONTROL GUNS - METERED



High flow oil control gun (BSP)

High volume oil control gun with flexible extension and manual non-drip nozzle. Fitted with trigger guard locking trigger and full flow 3/4" BSP(F) inlet swivel. Up to 10,350 kPa (1500 psi) maximum working pressure. Flow rate up to 57L/min (15 US gal/min). The Manual nozzle allows full flow with minimum pressure drop.



Manual non-drip nozzle

Flexible



Trigger guard

Full flow valve

Trigger Lock

Rotating swivel

Features & Benefits

- High volume gun suited to bulk dispensing of most types of service fluids used in mining or large workshops.
- Fitted with trigger guard and locking trigger
- Fitted with flexible extension & manual non-drip nozzle

Value Proposition

Allows high flow with minimum pressure loss.

Technical Specifications

- Flow Range: Up to 56 ltr / min (15 US GAL)
- Maximum Pressure: 105 BAR / 10500 kPa / 1500 PSI
- Maximum Operating Temp: 70 deg C (158 deg F)
- Weight: 1.8 KG
- Swivel Inlet: 3/4" BSPT or 3/4" NPT
- Fluid Compatibility: Transmission Fluid, Anti-freeze / Anti-Boil, Engine oil Diesel Oil, and Lubricating oils to SAE140

Package Includes:

- HG100 Handle
- Flexible extension
- Full flow manual non-drip nozzle

Applications:

Truck and Buses, Construction and Earthmoving, Military, Mining, Aircraft, Large oil transfer applications

High flow oil control guns



HG100-01

HG100-01-11

HG100-019E-01

	HG100-01	HG100-01-11	HG100-019E-01
Flow range	up to 57 L/min	up to 57 L/min	3 - 57 L/min
Inlet swivel	3/4" BSP (F)	3/4" BSP (F)	3/4" BSP (F)
Meter	x	x	Oval gear / Digital
Meter accuracy	x	x	+/- 0.5% (lube oils)
Features	Hi-Flow. Heavy duty design. Trigger Guard for hand protection. Balanced valve assembly for max flow control.	Hi-Flow (Zinc model). Heavy duty design. Trigger Guard for hand protection. Balanced valve assembly for max flow control.	Includes all HG100 Std features plus 6-digit digital display, resettable batch totaliser, resettable and non resettable totals, flow rate mode, c/w protective shroud.
Extension	flexible	flexible	flexible
Non drip nozzle	manual	manual	manual
Latching trigger	✓	✓	✓
Fully serviceable	✓	✓	✓
Warranty¹	10 years	10 years	10 years
Compatible fluids	oils up to SAE140, automatic trans fluid, engine oil, gear oil, hydraulic oil, coolant		
Max working pressure	10 350kPa (1500psi)	10 350kPa (1500psi)	10 350kPa (1500psi)
NPT Models	HG100-02		HG100-019E-02

Note¹ Subject to Macnaught warranty terms and conditions

CONTROL GUNS - METERED



Metered Oil Control Guns

The Reliable HG20 oil gun is fitted with a digital meter and is ideal for all types of workshops and automotive dealership applications. The HG20 is designed with a trigger lock on the handle and is supplied complete with flexible extension and automatic non drip nozzle. The meter accuracy is +/- 0.5% of reading.



Nozzle
Non drip Automatic nozzle to avoid oil spillage

Straight Flexible Extension
For easy access to tight spaces

Trigger Guard
To avoid accidental dispensing of fluid



HG20F-012E-01

Accurate electronic meter
+/- 0.5% of reading

Electronic Flow meter
6-digit digital display resettable batch totaliser, resettable and non-resettable total

Trigger lock
Trigger can be locked for ease of dispensing the fluid

CONTROL GUNS - METERED



HG20R-012E-01



HG20F-012M-01



HG20F-012E-01

Part Number (BSP models)	HG20R-012E-01	HG20F-012M-01	HG20F-012E-01
Description	Electronic meter with Rigid Extension	Mechanical meter with Flexible Extension	Electronic meter with Flexible Extension
Flow range	Up to 25L/min (6.6gal/min)	Up to 25L/min (6.6gal/min)	Up to 25L/min (6.6gal/min)
Inlet swivel	1/2" BSP(F)	1/2" BSP (F)	1/2" BSP(F)
Meter (oval gear)	Electronic	Mechanical	Electronic
Meter Accuracy	+/- 0.5%	+/- 1%	+/- 0.5%
Min/Max Temp	14°C (6.8°F) - 55°C (131°F)	14°C (6.8°F) - 55°C (131°F)	14°C (6.8°F) - 55°C (131°F)
Features	6 digit totaliser	7 digit totaliser	6 digit totaliser
Extension	Rigid with non-drip nozzle	Flexible with non-drip nozzle	
Latching Trigger	✓	✓	✓
Compatible Fluids	Engine, gear, ATF, hydraulic oils up to SAE140 viscosity & anti-freeze/anti boil		
Max Working Pressure	6, 900 kPa (1, 000 psi)	6, 900 kPa (1, 000 psi)	6, 900 kPa (1, 000 psi)
Weight (with fittings)	1.5Kg (3.3lb)	1.5Kg (3.3lb)	1.5Kg (3.3lb)
NPT Models	HG20R-012E-02		HG20F-012E-02

Why choose this product?
Peace of mind reliability.

Package Includes:

- HG20 oil control gun
- IM012E electronic meter
- Flexible Extension
- Automatic non-drip nozzle

Service Parts

- HG20-1K: Gun Seal Kit

Applications:

Suitable for use in most oil dispensing systems

Recommended to be used with:



OIL CONTROL GUNS - METERED



Control Guns - Metered (HG series)

Top of the range presettable electronic oil control gun with rigid extension. Features include locking trigger and non-drip nozzle, 5 presettable totals, resettable batch total and a non-resettable total. The meter accuracy is +/- 0.5 % of reading, working pressures up to 1500psi (10, 350kPa) and flow rates from 1 to 30L/min (4 to 8 US gal/min) the gun features self correcting algorithm.



HG55-01

All models include automatic non-drip nozzle
With unique thermal expansion piston to prevent annoying drips

Proven oval gear accuracy
Self correcting algorithm for highest accuracy

Ergonomic handles
Incorporating latching trigger mechanism for a positive release

Accurate electronic meter
+/- 0.5% of reading

5 presettable totals
Offers 5 different dispense memory settings for common delivery volumes

Heavy duty construction
To deliver industry leading strength and durability

Why choose this product?

Tough unit construction with cast aluminium chassis, providing both efficient ergonomics and solid protection of internals against damage.

Applications:
Suitable for use on most oil installations

Service Parts

- HG50-1K: Major Service Kit (HG55/HG60)
- HG50-2K: Valve Service Kit (HG40/HG55/HG60)
- HG040AS: HG40, HG50, HG60 Swivel Assembly
- HG370AS: HG60 Preset Module (for HG60)
- HG369AS: HG55 Electronic Module (for HG55)
- HG200AS: HG40 Register Assembly (for HG40)

Control Guns - Metered (HG series)



HG40-01

HG55-01

HG60-01

Part Number (BSP models)	HG40-01	HG55-01	HG60-01
Description	Oil Control Gun with Mechanical Meter	Oil Control Gun with Mechanical Meter	Oil Control Gun with Preset Electronic Meter
Flow range	1-30 L/min (0.26 - 8 gal/min)	1-30 L/min (0.26 - 8 gal/min)	1-30 L/min (0.26 - 8 gal/min)
Inlet swivel	1/2" BSP (F)	1/2" BSP (F)	1/2" BSP (F)
Meter	Oval gear / mechanical	Oval gear / digital	Oval gear / digital
Meter accuracy (Flow rate)	+/- 1% (lube oils)	+/- 0.5% (lube oils)	+/- 0.5% (lube oils)
Features	4-digit resettable batch totaliser 6-digit accumulative totaliser	5-digit resettable batch totaliser 6-digit accumulative totaliser sleep mode to conserve battery life EEPROM information retention for battery change	Pre-settable to 1999.9ltrs, AUTO Shut-off 5-digit resettable batch totaliser 6-digit accumulative totaliser sleep mode to conserve battery life EEPROM information retention for battery change
Operating temperature	0°C - 50°C (32°F-122°F)	0°C - 50°C (32°F-122°F)	0°C - 50°C (32°F-122°F)
Maximum pressure	1,500psi (10, 350kPa)	1,500psi (10, 350kPa)	1,500psi (10, 350kPa)
Extension	Rigid	Rigid	Rigid
Non drip nozzle	Automatic	Automatic	Automatic
Latching trigger	✓	✓	✓
NPT Models	HG40-02	HG55-02	HG60-02

Recommended to be used with:



IN-LINE OIL FLOW METERS



Electronic Oil Meter - 1/2" BSP/NPT

In-line oval gear meter with electronic register designed to accurately measure lubricating oils. Flow rate up to 30L/min (8 US gal/min), with an accuracy of +/- 0.5% of reading and a maximum pressure rating up to 6,900 kPa (1,000psi). The meter has a large LC display with both batch and cumulative totals. Fitted with either 1/2" BSP / NPT(F) ports.



Accuracy
Accurate reading to +/-0.5% with maximum pressure to 6,900kPa (1,000psi)

Large display
Digital display showing both cumulative & push-button reset batch totals



IM012E-01

1/2" BSP or NPT Ports
Suitable for most oil applications

Resettable batch total 6-digit digital display resettable batch totaliser, resettable and non-resettable totals

Why choose this product?

Economic, accurate and reliable electronic flow meter.

Applications:

Suitable for in line oil line applications or added to oil control gun

In-line Oil Meters



IM012E-01



IM019E-01



IM012M-01



IM012P-01



IM019P-01

Part Number (BSP models)	IM012M-01	IM012E-01	IM012P-01	IM019E-01	IM019P-01
Description	Mechanical Oil Meter - 1/2"	Electronic Oil Meter - 1/2"	Pulse Oil Meter - 1/2"	Electronic Oil Meter - 3/4"	Pulse Oil Meter - 3/4"
Flow range	1-30 L/min (0.26 - 8 gal/min)	1-30 L/min (0.26 - 8 gal/min)	1-30 L/min (0.26 - 8 gal/min)	3 - 80L/min (0.8 - 21 gal/min)	3 - 80L/min (0.8 - 21 gal/min)
Maximum pressure	1,000psi (6,900kPa)	1,000psi (6,900kPa)	1,000psi (6,900kPa)	1,000psi (6,900kPa)	1,000psi (6,900kPa)
Maximum temperature	55°C (131°F)	55°C (131°F)	55°C (131°F)	55°C (131°F)	55°C (131°F)
Meter / register	Oval gear / Mechanical	Oval gear / Digital	Oval gear / Pulse output	Oval gear / Digital	Oval gear / Pulse output
Accuracy (flow rate)	+/- 1% (lube oils)	+/- 0.5% (lube oils)	+/- 0.5% (lube oils)	+/- 0.5% (lube oils)	+/- 0.5% (lube oils)
Features	4-digit resettable batch totaliser 7-digit accumulative totaliser	6-digit digital display resettable batch totaliser	Pulse output model includes 1m fly lead either reed switch and/or hall effect sensor	6-digit digital display resettable and non resettable totals	Pulse output model includes 1m fly lead either reed switch and/or hall effect sensor
Protective shroud	✓	✓	✓	✓	✓
Inlet port	1/2" BSP (F)	1/2" BSP (F)	1/2" BSP (F)	3/4" BSP (F)	3/4" BSP (F)
Outlet port	1/2" BSP (F)	1/2" BSP (F)	1/2" BSP (F)	3/4" BSP (F)	3/4" BSP (F)
Compatible fluids	Oils up to SAE140, automatic trans fluid, engine oil, gear oil, hydraulic oil, coolant, diesel, kerosene				
NPT Models	IM012M-02	IM012E-02	IM012P-02	IM019E-02	IM019P-02

Recommended to be used with:

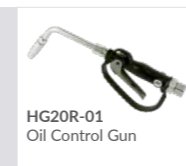

HG20R-01 Oil Control Gun

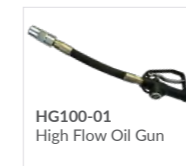

HG100-01 High Flow Oil Gun

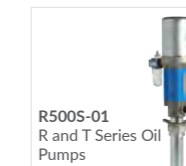

R500S-01 R and T Series Oil Pumps

4 WAY EVACUATION VALVES

4 Way Evacuation Valves

4 Way Evacuation Valve is used for the extraction and discharge of fluids which reduces the necessity of multiple valves controlling fluid flow. The fluid can be waste oil, hydraulic, gear and engine oil, ATF or coolants. The valve makes the operation easier for the transfer of fluid by just shifting the lever which reverses the flow of the fluid from filling to discharging the waste oil/fluids or vice versa. This valve requires only one pump for both the operation and is simplified without the hose/pipe connections being altered.



Easy Operation

The 4 Way Evacuation Valve makes operation easy for the transfer of fluid by reducing the necessity for multiple valves.

Dimensions

105mm x 105mm x 90mm
Weight = 1kg (2.2lbs)

Easy Installation

Four pre-drilled mounting holes - M8x1.25 have been provided for convenient installation.



Reverse Flow
Extraction and Discharge of fluids can be controlled by just repositioning the handle to the desired requirement.

Single Pump
One pump is sufficient for both operations (discharge and extraction of fluid) which simplifies the plumbing.

No Flow restriction
There will be no pressure or volume loss during the flow in either direction.

Why choose this product?

The Macnaught 4 Way Evacuation Valves make it easier to transfer fluid by simply shifting the lever to fill or discharge fluids using only one pump.

Applications:

- Transfer Fluids from bulk supply containers to daily operational tanks.
- Extraction and discharge of various types of fluids on lube/service trucks.
- Extraction of fluids from engines set in remote locations- irrigation fields/ mining sites

Part Number	M4WV19	M4WV25	M4WV38
Description	3/4" BSP Inlet/Outlet Connections	1" BSP Inlet/Outlet Connections	1 1/2" BSP Inlet/Outlet Connections
Inlet/ Outlet	3/4" BSP	1" BSP	1 1/2" BSP
Max Working Pressure	200psi (14bar)	200psi (14bar)	200psi (14bar)

Recommended to be used with	Recommended to be used with	Recommended to be used with
M4WV19:	M4WV25:	M4WV38:

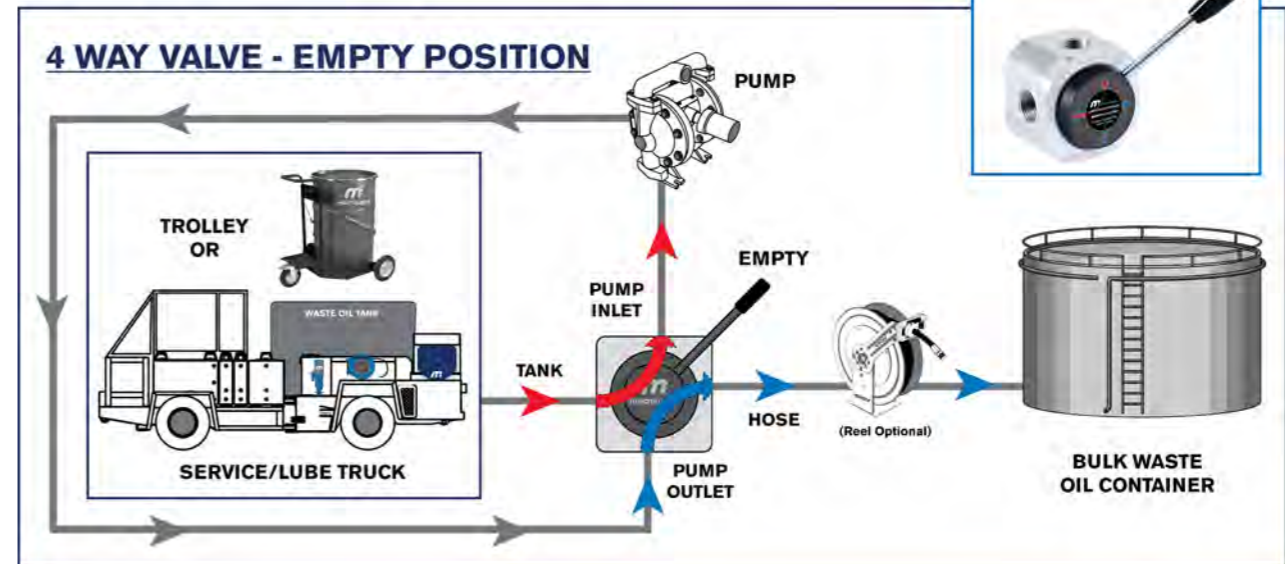
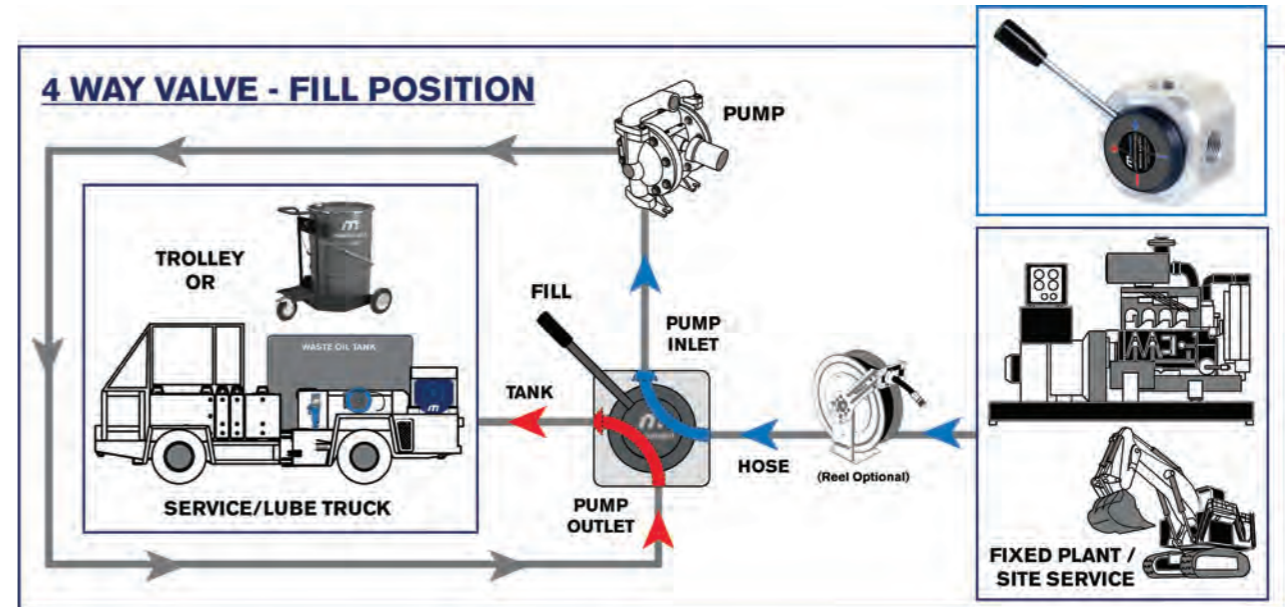

* The suction line of the pump should be as close as possible to the suction point.

4 Way Evacuation Valve Kits

EVACTR-MC Kit includes

- M4WV19 - 3/4" Four way valve
- DDP19 - Double diaphragm pump
- TR205-01 - 205ltr Drum Trolley
- L-FS19 - 3/4" Swivel
- Suction tube assembly
- Camlock fittings
- All the required hoses and fittings



*205L drum not included

- Long delivery hose
- Suction tube and bung adaptor assembly
- Can lock fittings for quick removal and connection
- 3/4" double diaphragm pump (heavy duty and reliable)
- Swivel caster with wheel lock break for safety while in use
- Heavy duty TR205 drum trolley allows easy access as required

EVACTR-MC

ELECTRIC OIL PUMPS

240V Electric Oil Pumps

Macnaught's range of Oil handling equipment has been enhanced by the addition of new 240V Electric Oil Pumps for a flexible alternative to traditional Manual and pneumatic oil pumps. The Electric Oil Pump heads are constructed from robust cast iron with sintered steel impeller, Viton seal and POM (polyoxymethylene) vanes to reduce wear and maximise the operational life of the unit. The pumps are rated to IP55 and have 240V single phase motors with a 30 minute duty cycle, supplied with 2m cable complete with standard 3 pin plug and built in on/off switch. Available in two models with flow rates from 25lpm and 50lpm, the EOP25-240V and EOP50-240V are suitable for oils and diesel fuel with viscosity up to 500cSt at 40deg C. Producing up to 100psi of head pressure and offering up to 2m of suction head, the new Electric Oil Pumps from Macnaught are built tough for most oil and diesel transfer applications.



EOP25-240V
EOP50-240V

240V ADBLU/DEF Pump

The 240V Electric AdBlue Pump is a great addition to Macnaught's range of AdBlue transfer and dispense equipment. The new electric AdBlue/DEF pump heads are diaphragm type constructed from durable Nylon 6 with EPDM diaphragms and NBR seals to reduce wear and increase chemical compatibility. The pumps have IP55 protection and have 240V single phase motors with a 20 minute duty cycle and supplied with 2m cable complete with standard 3 pin plug and built in on/off switch. The EABP34-240V is suitable for Urea based diesel exhaust fluids such as AdBlue and DEF as well as compatible with water at temperatures up to 40°C. Producing up to 100psi of head pressure and offering up to 2m of suction head, the new electric AdBlue pumps from Macnaught are purpose built for diesel exhaust fluid transfer applications.



EABP34-240V

Part Number	EOP25-240V	EOP50-240V
Description	240V Electric Oil Pumps	240V Electric Oil Pumps
Flow range	25 l/m	50 l/m
Volt	240V	240V
Power	828W	1081W
Inlet/ Outlet	1" BSPP (F)	1" BSPP (F)
Max current draw	4.5 A	47 A
Duty Cycle	30mins	30mins

Part Number	EABP34-240V
Description	240V Electric Oil Pumps
Flow range	25 l/m
Volt	240V
Power	828W
Inlet/ Outlet	1" BSPP
Max current draw	2 A
Duty Cycle	30mins

OTSB TANKS (OIL TANKS SINGLE BUND)

The OTSB bulk storage tanks are constructed with both an inner tank and outer tank. The inner tank is manufactured from high molecular HDPE, with the outer tank constructed from galvanised sheet metal. The outer tank functions as a collecting tray and has the capacity to hold the full volume of the inner tank. The tank design is suitable for the storage of a single fluid and can be used for the storage of many fluids such as Lubricating oils, heat transfer oils, mineral oils, hydraulic oils, fatty oils, fuel oil, diesel in the private, industrial and commercial sector. Integrated handles enable easy handling of the tank. The low centre of gravity provides a high degree of static stability. These tanks are compact and available in different sizes (400L/750L/1000L/1500L) providing more flexibility for placement in any workshop.



OTSB TANKS



Suitable for lubricating oils, transfer oils, mineral oils, hydraulic oils, fuel oil and diesel

Low centre of gravity provides a high degree of static stability

Optical leak probe and level indicator

Inner tanks blow moulded, high molecular HDPE, is corrosion-resistant

Outer tank is galvanised sheet metal that acts as a collecting tray to hold full volume of inner tank

Base frame ensures adequate ventilation under the tank

OTSB1500

OTSB400

OTSB750

OTSB1000

OTSB1500

Why choose this product?

A quality economical solution to your bulk oil storage requirements. Slim design allows the tank to be installed in the workshop taking up minimum of space.

Applications:

Ideal for use in Automotive, truck and bus workshops or for use for any bulk storage requirements.

Ordering information (tank only)

PART NUMBER	CAPACITY	L X W X H	WEIGHT
OTSB400	400L	740 X 700 X 1170mm	58Kg
OTSB750	750L	980 X 760 X 1420mm	81Kg
OTSB1000	1000L	1280 X 760 X 1420mm	104Kg
OTSB1500	1500L	1630 X 760 X 1860mm	160Kg

Recommended to be used with:

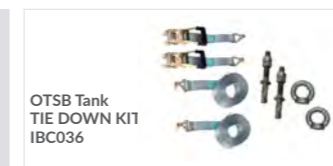

OTSB TANKS & DISPENSE PACKAGES



MACNAUGHT OTSB TANK PACKAGES

Providing a complete solution from small to heavy duty fluid dispensing applications. The Macnaught OTSB Tank packages are built or configured exclusively for Macnaught branded equipment. The package includes either a R-Series or T-Series pump, sturdy mounting bracket, and various equipment options to choose such as heavy-duty Oil Reel, In-line Meter, Metered or Unmetered oil gun. The packages will be shipped with all the necessary components and accessories to build a complete storage and dispensing system.



OTSB TANK PACKAGES

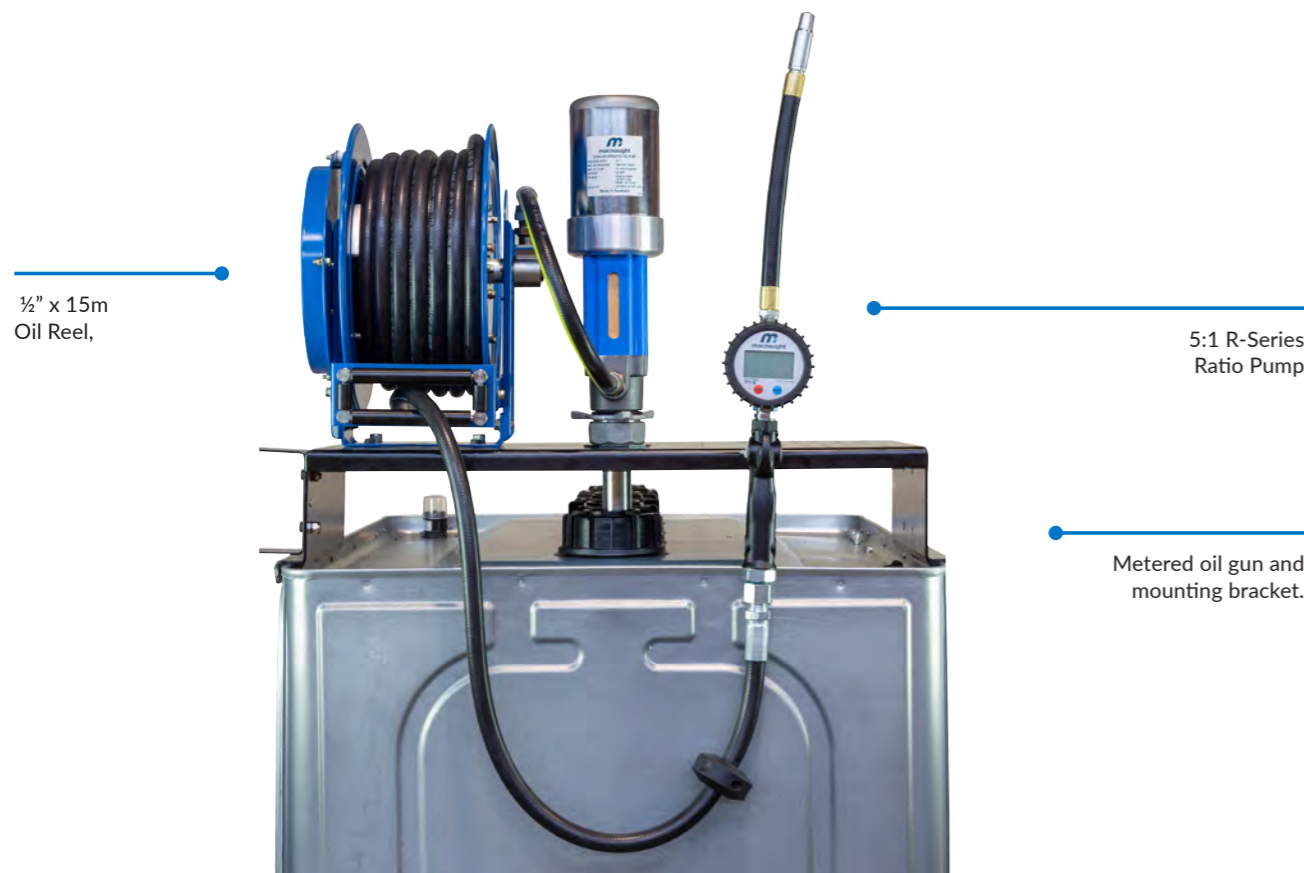

1/2" x 15m Oil Reel,

5:1 R-Series Ratio Pump

Metered oil gun and mounting bracket.

OTS1215-R5E



OTS1215-T5IM



OTS-R5

Why choose this product?

A quality economical solution to your bulk oil storage requirements. Slim design allows the tank to be installed in the workshop taking up minimum of space.

Applications:

Ideal for use in Automotive, truck and bus workshops or for use for any bulk storage requirements.

Recommended to be used with:



OTSB Tank TIE DOWN KIT IBC036

Kit Parts:

- MOTP1215-01: 1/2" x 15m Twin Pedestal Oil Reel
- R500S-01: 5:1 Ratio Oil Pump
- HG20F-012E-01: Oil Control Gun with Electronic Meter and Flexible extension.
- Mounting Bracket suitable for all OTSB tanks.
- All necessary hoses and fitting components included.

SUITABLE MODELS FOR 400L TANK

Part no (w/o tank)	Macnaught Oil Pump	Twin Pedestal Macnaught Reel	Oil Control Gun & In-line Meter
OTS1215-R5E	5:1 R-Series	1/2" x 15m Reel	Metered
OTS1215-R5	5:1 R-Series	1/2" x 15m Reel	Un-metered
OTS1215-R5IM	5:1 R-Series	1/2" x 15m Reel	Un-metered & in-line meter
OTS-R5E	5:1 R-Series	X	Metered
OTS-R5	5:1 R-Series	X	Un-metered
OTS-R5IM	5:1 R-Series	X	Un-metered & in-line meter
OTS1215-T5E	5:1 T-Series	1/2" x 15m Reel	Metered
OTS1215-T5	5:1 T-Series	1/2" x 15m Reel	Un-metered
OTS1215-T5IM	5:1 T-Series	1/2" x 15m Reel	Un-metered & in-line meter
OTS-T5E	5:1 T-Series	X	Metered
OTS-T5	5:1 T-Series	X	Un-metered
OTS-T5IM	5:1 T-Series	X	Un-metered & in-line meter

SUITABLE MODELS FOR 750L, 1000L AND 1500L TANKS

Part no (w/o tank)	Macnaught Oil Pump	Twin Pedestal Macnaught Reel	Oil Control Gun & In-line Meter
OTL1215-R5E	5:1 R-Series	1/2" x 15m Reel	Metered
OTL1215-R5	5:1 R-Series	1/2" x 15m Reel	Un-metered
OTL1215-R5IM	5:1 R-Series	1/2" x 15m Reel	Un-metered & in-line meter
OTL-R5E	5:1 R-Series	X	Metered
OTL-R5	5:1 R-Series	X	Un-metered
OTL-R5IM	5:1 R-Series	X	Un-metered & in-line meter
OTL1215-T5E	5:1 T-Series	1/2" x 15m Reel	Metered
OTL1215-T5	5:1 T-Series	1/2" x 15m Reel	Un-metered
OTL1215-T5IM	5:1 T-Series	1/2" x 15m Reel	Un-metered & in-line meter
OTL-T5E	5:1 T-Series	X	Metered
OTL-T5	5:1 T-Series	X	Un-metered
OTL-T5IM	5:1 T-Series	X	Un-metered & in-line meter

Recommended to be used with:



OTSB400L, OTSB750L, OTSB1000L, OTSB1500L



"IBC031" - 400L, "IBC030" - 750L, 1000L, 1500L.



R-Series and T-Series 3:1 ratio pump (R300S-01 / T312S-01)

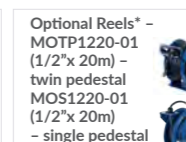

Optional Reels* - MOTP1220-01 (1/2"x 20m) - twin pedestal MOS1220-01 (1/2"x 20m) - single pedestal



"HG20R-01" Unmetered & Rigid "HG20R-012E-01" Metered & Rigid "HG55-01" Digital Metered Gun "HG60-01" Preset Digital Metered gun

OTSB TANK PACKAGES



List of all OTSB Tank Packages
(includes mounting bracket, hoses and all components)

Part Number (with Tank)	Tank P/n	Part No. (w/o Tank)	Pump	Hose Reel	Gun/Meter/4 Way Valve
OTS1215-R5400	OTSB400	OTS1215-R5	5:1 R-Series	1/2"x15m (MAC)	Metered gun
OTS1215-R5E400	OTSB400	OTS1215-R5E	5:1 R-Series	1/2"x15m (MAC)	Un-metered gun
OTS1215-R5IM400	OTSB400	OTS1215-R5IM	5:1 R-Series	1/2"x15m (MAC)	Un-metered gun & in-line meter
OTS1215-T5400	OTSB400	OTS1215-T5	5:1 T-Series	1/2"x15m (MAC)	Metered gun
OTS1215-T5E400	OTSB400	OTS1215-T5E	5:1 T-Series	1/2"x15m (MAC)	Un-metered gun
OTS1215-T5IM400	OTSB400	OTS1215-T5IM	5:1 T-Series	1/2"x15m (MAC)	Un-metered gun & in-line meter
OTS-R5400	OTSB400	OTS-R5	5:1 R-Series	X	Metered gun
OTS-R5E400	OTSB400	OTS-R5E	5:1 R-Series	X	Un-metered gun
OTS-R5IM400	OTSB400	OTS-R5IM	5:1 R-Series	X	Un-metered gun & in-line meter
OTS-T5400	OTSB400	OTS-T5	5:1 T-Series	X	Metered gun
OTS-T5E400	OTSB400	OTS-T5E	5:1 T-Series	X	Un-metered gun
OTS-T5IM400	OTSB400	OTS-T5IM	5:1 T-Series	X	Un-metered gun & in-line meter
OTS1215-L5400	OTSB400	OTS1215-L5	5:1 Stub	1/2"x15m (LM)	Metered gun
OTS1215-L5E400	OTSB400	OTS1215-L5E	5:1 Stub	1/2"x15m (LM)	Un-metered gun
OTS1215-L5IM400	OTSB400	OTS1215-L5IM	5:1 Stub	1/2"x15m (LM)	Un-metered gun & in-line meter
OTS-L5400	OTSB400	OTS-L5	5:1 Stub	X	Metered gun
OTS-L5E400	OTSB400	OTS-L5E	5:1 Stub	X	Un-metered gun
OTS-L5IM400	OTSB400	OTS-L5IM	5:1 Stub	X	Un-metered gun & in-line meter
OTS-DP194W400	OTSB400	OTS-DP194W	3/4" DDP	X	3/4" 4 Way valve
OTS1215-DPA400	OTSB400	OTS1215-DPA	1/2" DDP	1/2"x15m (LM)	Metered gun
OTS1215-DPAE400	OTSB400	OTS1215-DPAE	1/2" DDP	1/2"x15m (LM)	Un-metered gun
OTS-DPA400	OTSB400	OTS-DPA	1/2" DDP	X	Metered gun
OTS-DPAE400	OTSB400	OTS-DPAE	1/2" DDP	X	Un-metered gun
OTL1215-R5700	OTSB750	OTL1215-R5	5:1 R-Series	1/2"x15m (MAC)	Metered gun
OTL1215-R5E700	OTSB750	OTL1215-R5E	5:1 R-Series	1/2"x15m (MAC)	Un-metered gun
OTL1215-R5IM700	OTSB750	OTL1215-R5IM	5:1 R-Series	1/2"x15m (MAC)	Un-metered gun & in-line meter
OTL1215-T5700	OTSB750	OTL1215-T5	5:1 T-Series	1/2"x15m (MAC)	Metered gun
OTL1215-T5E700	OTSB750	OTL1215-T5E	5:1 T-Series	1/2"x15m (MAC)	Un-metered gun
OTL1215-T5IM700	OTSB750	OTL1215-T5IM	5:1 T-Series	1/2"x15m (MAC)	Un-metered gun & in-line meter
OTL-R5700	OTSB750	OTL-R5	5:1 R-Series	X	Metered gun
OTL-R5E700	OTSB750	OTL-R5E	5:1 R-Series	X	Un-metered gun
OTL-R5IM700	OTSB750	OTL-R5IM	5:1 R-Series	X	Un-metered gun & in-line meter
OTL-T5700	OTSB750	OTL-T5	5:1 T-Series	X	Metered gun
OTL-T5E700	OTSB750	OTL-T5E	5:1 T-Series	X	Un-metered gun
OTL-T5IM700	OTSB750	OTL-T5IM	5:1 T-Series	X	Un-metered gun & in-line meter
OTL1215-L5700	OTSB750	OTL1215-L5	5:1 Stub	1/2"x15m (LM)	Metered gun
OTL1215-L5E700	OTSB750	OTL1215-L5E	5:1 Stub	1/2"x15m (LM)	Un-metered gun
OTL1215-L5IM700	OTSB750	OTL1215-L5IM	5:1 Stub	1/2"x15m (LM)	Un-metered gun & in-line meter
OTL-L5700	OTSB750	OTL-L5	5:1 Stub	X	Metered gun
OTL-L5E700	OTSB750	OTL-L5E	5:1 Stub	X	Un-metered gun
OTL-L5IM700	OTSB750	OTL-L5IM	5:1 Stub	X	Un-metered gun & in-line meter
OTL-DP194W700	OTSB750	OTL-DP194W	3/4" DDP	X	3/4" 4 Way valve
OTL1215-DPA700	OTSB750	OTL1215-DPA	1/2" DDP	1/2"x15m (LM)	Metered gun
OTL1215-DPAE700	OTSB750	OTL1215-DPAE	1/2" DDP	1/2"x15m (LM)	Un-metered gun
OTL-DPA700	OTSB750	OTL-DPA	1/2" DDP	X	Metered gun
OTL-DPAE700	OTSB750	OTL-DPAE	1/2" DDP	X	Un-metered gun

List of all OTSB Tank Packages
(includes mounting bracket, hoses and all components)

Part Number (with Tank)	Tank P/n	Part No. (w/o Tank)	Pump	Hose Reel	Gun/Meter/4 Way Valve
OTL1215-R51000	OTSB1000	OTL1215-R5	5:1 R-Series	1/2"x15m (MAC)	Metered gun
OTL1215-R5E1000	OTSB1000	OTL1215-R5E	5:1 R-Series	1/2"x15m (MAC)	Un-metered gun
OTL1215-R5IM1000	OTSB1000	OTL1215-R5IM	5:1 R-Series	1/2"x15m (MAC)	Un-metered gun & in-line meter
OTL1215-T51000	OTSB1000	OTL1215-T5	5:1 T-Series	1/2"x15m (MAC)	Metered gun
OTL1215-T5E1000	OTSB1000	OTL1215-T5E	5:1 T-Series	1/2"x15m (MAC)	Un-metered gun
OTL1215-T5IM1000	OTSB1000	OTL1215-T5IM	5:1 T-Series	1/2"x15m (MAC)	Un-metered gun & in-line meter
OTL-R51000	OTSB1000	OTL-R5	5:1 R-Series	X	Metered gun
OTL-R5E1000	OTSB1000	OTL-R5E	5:1 R-Series	X	Un-metered gun
OTL-R5IM1000	OTSB1000	OTL-R5IM	5:1 R-Series	X	Un-metered gun & in-line meter
OTL-T51000	OTSB1000	OTL-T5	5:1 T-Series	X	Metered gun
OTL-T5E1000	OTSB1000	OTL-T5E	5:1 T-Series	X	Un-metered gun
OTL-T5IM1000	OTSB1000	OTL-T5IM	5:1 T-Series	X	Un-metered gun & in-line meter
OTL1215-L51000	OTSB1000	OTL1215-L5	5:1 Stub	1/2"x15m (LM)	Metered gun
OTL1215-L5E1000	OTSB1000	OTL1215-L5E	5:1 Stub	1/2"x15m (LM)	Un-metered gun
OTL1215-L5IM1000	OTSB1000	OTL1215-L5IM	5:1 Stub	1/2"x15m (LM)	Un-metered gun & in-line meter
OTL-L51000	OTSB1000	OTL-L5	5:1 Stub	X	Metered gun
OTL-L5E1000	OTSB1000	OTL-L5E	5:1 Stub	X	Un-metered gun
OTL-L5IM1000	OTSB1000	OTL-L5IM	5:1 Stub	X	Un-metered gun & in-line meter
OTL-DP194W1000	OTSB1000	OTL-DP194W	3/4" DDP	X	3/4" 4 Way valve
OTL1215-DPA1000	OTSB1000	OTL1215-DPA	1/2" DDP	1/2"x15m (LM)	Metered gun
OTL1215-DPAE1000	OTSB1000	OTL1215-DPAE	1/2" DDP	1/2"x15m (LM)	Un-metered gun
OTL-DPA1000	OTSB1000	OTL-DPA	1/2" DDP	X	Metered gun
OTL-DPAE1000	OTSB1000	OTL-DPAE	1/2" DDP	X	Un-metered gun
OTL1215-R51500	OTSB1500	OTL1215-R5	5:1 R-Series	1/2"x15m (MAC)	Metered gun
OTL1215-R5E1500	OTSB1500	OTL1215-R5E	5:1 R-Series	1/2"x15m (MAC)	Un-metered gun
OTL1215-T51500	OTSB1500	OTL1215-T5	5:1 T-Series	1/2"x15m (MAC)	Metered gun
OTL1215-T5E1500	OTSB1500	OTL1215-T5E	5:1 T-Series	1/2"x15m (MAC)	Un-metered gun
OTL-R51500	OTSB1500	OTL-R5	5:1 R-Series	X	Metered gun
OTL-R5E1500	OTSB1500	OTL-R5E	5:1 R-Series	X	Un-metered gun
OTL-T51500	OTSB1500	OTL-T5	5:1 T-Series	X	Metered gun
OTL-T5E1500	OTSB1500	OTL-T5E	5:1 T-Series	X	Un-metered gun
OTL1215-L51500	OTSB1500	OTL1215-L5	5:1 Stub	1/2"x15m (LM)	Metered gun
OTL1215-L5E1500	OTSB1500	OTL1215-L5E	5:1 Stub	1/2"x15m (LM)	Un-metered gun
OTL-L51500	OTSB1500	OTL-L5	5:1 Stub	X	Metered gun
OTL-L5E1500	OTSB1500	OTL-L5E	5:1 Stub	X	Un-metered gun
OTL-DP194W1500	OTSB1500	OTL-DP194W	3/4" DDP	X	3/4" 4 Way valve
OTL1215-DPA1500	OTSB1500	OTL1215-DPA	1/2" DDP	1/2"x15m (LM)	Metered gun
OTL1215-DPAE1500	OTSB1500	OTL1215-DPAE	1/2" DDP	1/2"x15m (LM)	Un-metered gun
OTL-DPA1500	OTSB1500	OTL-DPA	1/2" DDP	X	Metered gun
OTL-DPAE1500	OTSB1500	OTL-DPAE	1/2" DDP	X	Un-metered gun

OIL ACCESSORIES



FLEXIBLE EXTENSION - 10" WITH AUTO NOZZLE
HGFNZ
 250mm (10") flexible extension with automatic non-drip nozzle for HG40 /HG55/ HG60 oil control guns



RIGID EXTENSION - 6" HGREX
 150mm (6") Rigid extension for several types of oil control guns. Replacement unit for HG40/ 55 /60



FLEXIBLE EXTENSION - 10" WITHOUT NOZZLE
HGFEX
 250mm (10") Flexible extension for oil control guns. Replacement unit for HG40 /55 /60



WALL MOUNT BRACKET TD20-BLACKS
 Wall mounting bracket for air operated oil pumps. Uses standard 2" bung adaptor connection. Suits all R-Series™ and OILMASTER® oil pumps



TELESCOPIC SUCTION TUBE TB25S
 1" BSP (M), length 615 - 1035mm (24" - 40"). Suits all Macnaught 'R' and 'T' series stub pumps



REMOTE SUCTION KIT - IBC RSK-IBC
 2.4m (8ft) hose, fittings, & 3" connector to suit IBC bottom outlet



RIGID EXTENSION WITH NON-DRIP NOZZLE HGRNZ
 150mm (6") ridged extension with automatic non-drip nozzle for HG40 /HG55 /HG60 oil control guns



AUTOMATIC NON-DRIP NOZZLE HGNZL
 Fully automatic non-drip nozzle using unique patented technology. Standard equipment on all HG40/55/60

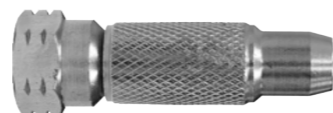

MANUAL NON-DRIP NOZZLE HGMNZL
 Manual non-drip nozzle 1/4" NPT (F) to suit most brands of oil control guns



LUBRICATOR KIT TA-3K
 1/4" Airline lubricator used to add oil into airline to lubricate and protect pumps from corrosion and seal wear. Suits all R-Series™ and oil pumps



WALL MOUNT KIT (BRACKET ONLY) TA-2K
 A bracket set to join the TA-7K filter/regulator & the TA-3K lubricator together to form a neat unit (Bracket only). Note: Lubricators shown are for illustration purposes only



MOUNTING BRACKET IBC031S / IBC030S
 IBC031S - Mounting Bracket for 400L Tank
 IBC030S - Mounting Bracket for 750L, 1000L, 1500L



OIL FEEDER HOSE TB-20K 5:1 RATIO TB-20K
 Feeder hose - 3.0m (10ft) x 12.5mm (1/2") i.d. - 6900kPa (1000psi). 3/4" BSP (M) swivel x 1/2" BSP (M) fitting with 3/4" reducer. Suitable for R-Series™ & OILMASTER® in 5:1 & 10:1 ratio pumps



OIL FEEDER HOSE TD-25K 3:1 RATIO TD-25K
 Feeder hose - 3.0m (10ft) x 12.5mm (1/2") i.d. - 2,800kPa (400psi). 3/4" BSP (M) swivel x 1/2" BSP (M) fitting with 3/4" reducer. Suitable for R-Series™ & OILMASTER® in 3:1 ratio pumps



FILTER AND REGULATOR KIT TA-7K
 1/4" Airline filter and regulator kit. Used to regulate the air pressure to the air operated equipment as well as remove dust, dirt & moisture from the air supply



QUICK RELEASE AIRLINE FITTING KIT TA-5K
 A snap on connector for easy connection of air powered equipment to the airline. Thread size: 1/4" BSP.



STRAIGHT FLEXIBLE EXTENSION WITH AUTO NOZZLE HGFFNZ
 250mm (10") flexible extension with automatic non-drip nozzle for HG40/HG55/ HG60 oil control guns



IN-LINE FILTER/STRAINER CF
 Fine mesh strainer to fit C7 or C11 pumps. Highly recommended when dispensing either ATF or hydraulic oils to trap small particles



REMOTE SUCTION KIT - DRUM RSK-DRUM
 2.4m (8ft) hose, fittings & suction tube to suit drum bung mounting



ON/OFF AIR VALVE SETS TA16S
 Reliable on/off air valve for use with air operated grease and oil pumps



DRUM TROLLEY - 20L TR5-01
 Drum trolley for 20kg (44lb) grease drums and 20L (5gal) oil drums



DRUM TROLLEY - 60L TR6-01
 Drum trolley for 55Kg (120lb) grease drums and 60L (16gal) oil drums



TROLLEY TR205-01
 Heavy duty trolley designed to suit drums up to 205L (54gal) and 180kg (400lb). Large main wheels with a steerable braked third wheel. Very low loading height

MANUAL PUMPS

RAPIDFLO™ Rotary Fuel Pumps



RAPIDFLO™ with Filter
GTF-01
 VA-01 filter included

RAPIDFLO™ with Filter and Wrench
GT-01/WRENCH
 VA-01 filter and L-DWA wrench included

RAPIDFLO™ with Filter and Meter
GTFM-01
 HA1S-01 Filter, DM100-01 Meter and fittings included



ROTARY VANE PUMPS



RVP with Filter
RVPF-01
 VA-01 filter included

RVP with Filter and Meter
RVPFM-01
 HA1S-01 Filter, DM100-01 Meter and fittings included



Part Number	GT-01	GT-01BD	GT-01/WRENCH	GTF-01	GTFM-01
Description	RAPIDFLO™ Rotary Fuel Pump	RAPIDFLO™ Rotary Fuel Pump - Biodiesel Version	RAPIDFLO™ with Filter and Wrench	RAPIDFLO™ with Filter	RAPIDFLO™ with Filter and Meter
Pump output	0.8L/rev (typical delivery rate 100L/min (26GAL))				
Action	Bi-lobe rotary	Bi-lobe rotary	Bi-lobe rotary	Bi-lobe rotary	Bi-lobe rotary
Hose	2.4m anti-static rubber hose				
Drum size	205L (54 gal)	205L (54 gal)	205L (54 gal)	205L (54 gal)	205L (54 gal)
Drum adaptor	2" Sliding	2" Sliding	2" Sliding	2" Sliding	2" Sliding
Lockable handle	✓	✓	✓	✓	✓
Nozzle holder	✓	✓	✓	✓	✓
Built in strainer	✓	✓	✓	✓	✓
Compatible Fluids	Diesel, ULP, aviation fuels, kerosene, lubricating oils to SAE30	Biodiesel, kerosene and lubricating oils to SAE30	Diesel, ULP and kerosene		
Wetted Components	Aluminium, steel, zinc, nitrile, rubber and viton				
Filter	X	X	VA-01	VA-01	HA1S-01
Drum Wrench	X	X	L-DWA	X	X
Meter	X	X	X	X	DM100-01
Connector Kit	X	X	X	X	DV-01

Part Number	RVP-01	RVPF-01	RVPFM-01
Description	Rotary Vane Pump	Rotary Vane Pump with Filter	Rotary Vane Pump with Filter & Meter
Pump output	Typical delivery rate 20L/min(5gal/min)	Typical delivery rate 20L/min(5gal/min)	Typical delivery rate 20L/min(5gal/min)
Action	Rotary	Rotary	Rotary
Hose	1.8m (6ft) PVC/Nitrile hose	1.8m (6ft) PVC/Nitrile hose	1.8m (6ft) PVC/Nitrile hose
Drum size	60L - 205L (16-54 gal)	60L - 205L (16-54 gal)	60L - 205L (16-54 gal)
Drum adaptor	2" Sliding	2" Sliding	2" Sliding
Lockable handle	✓	✓	✓
Nozzle holder	✓	✓	✓
Built in strainer	✓	✓	✓
Compatible Fluids	Diesel and kerosene (filters not suitable for aviation fuels)		
Wetted Components	Aluminium, steel, zinc and nitrile rubber		
Filter	X	VA-01	HA1S-01
Meter	X	X	DM100-01
Connector Kit	X	X	DV-01

Note* - Users of aviation fuels must check material compatibility with the fuel product they are using. Note* Subject to Macnaught warranty terms and conditions

Note* Subject to Macnaught warranty terms and conditions

ELECTRIC FUEL PUMPS



Electric Diesel Pump Kits

Ideal for portable diesel transfer applications including bulk tank, service truck or utility vehicle applications, these 12/24V ELECTRIC DIESEL PUMP KITS are an economical alternative to manual pumps. These self-priming vane pumps are fitted with a built-in bypass valve and deliver up to 40L/min (free flow) and have a 30 minute duty cycle. The pumps are supplied complete with everything needed for the operator to start transferring diesel. For the best control and accuracy, it is recommended to use the appropriate Macnaught digital diesel meter and filter.



Portable 40L/min Diesel Pump
Available in 12V or 24V models

Pump Package
Includes nozzle, suction hose, delivery hose and fittings

Manual or automatic nozzle
Options available to suit different conditions

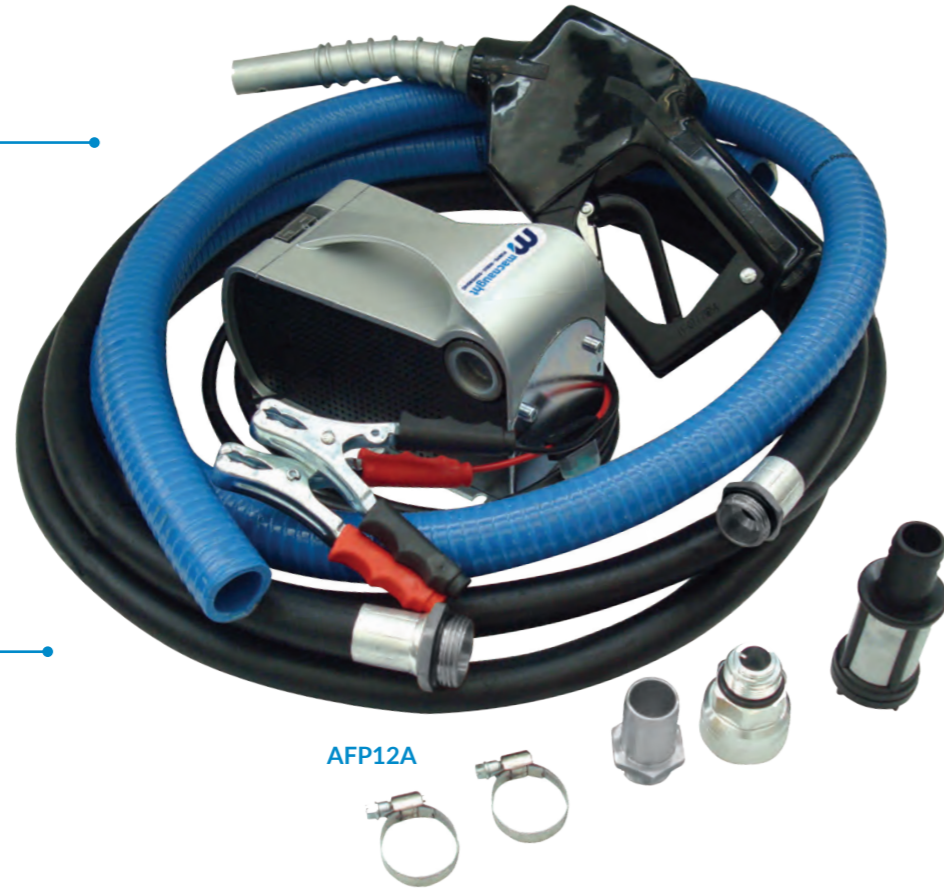

AFP12A

Why choose this product?

Premium quality electric diesel pump kits. Complete kit ready to go.

Applications:

Ideal for use on any diesel transfer application.

Service Parts

- **AFP12-1K:** Pump Service Parts
- **AFP12-2K:** Poppet Valve Kit
- **A40LPM-SWITCH:** On/Off Switch

12V / 24V Electric Diesel Pump Kits



12V ELECTRIC DIESEL PUMP KIT
MANUAL NOZZLE
AFP12M



12V ELECTRIC DIESEL PUMP
KIT AUTOMATIC NOZZLE
AFP12A

Part Number	AFP12M	AFP12A	AFP24M	AFP24A
Description	12V Electric Diesel Pump Kit Manual Nozzle	12V Electric Diesel Pump Kit Auto Nozzle	24V Electric Diesel Pump Kit Manual Nozzle	24V Electric Diesel Pump Kit Auto Nozzle
Flow range	40L/min (11 gal/min)	40L/min (11 gal/min)	40L/min (11 gal/min)	40L/min (11 gal/min)
Volt	12V	12V	24V	24V
Inlet/ Outlet	3/4" BSP (F)	3/4" BSP (F)	3/4" BSP (F)	3/4" BSP (F)
Duty Cycle	30min	30min	30min	30min
Suction hose	25mm (1") x 2m (6.5ft)	25mm (1") x 2m (6.5ft)	25mm (1") x 2m (6.5ft)	25mm (1") x 2m (6.5ft)
Delivery hose	19mm (3/4") x 4m (13ft) power cable with alligator clips	19mm (3/4") x 4m (13ft) power cable with alligator clips	19mm (3/4") x 4m (13ft) power cable with alligator clips	19mm (3/4") x 4m (13ft) power cable with alligator clips
Suitable fluids	*Suitable for diesel use only			

Recommended to be used with:



ADTFM
Digital Fuel Meter



ATS205
Telescopic Suction Tube

ELECTRIC FUEL PUMPS



12V High Flow Wall Mount Diesel Pump Kit

The 12V WALL MOUNT KIT is ideal for portable diesel transfer including bulk tank, service truck or utility vehicle applications. This 60 litres per minute pump is supplied with a high flow 12V pump, mechanical flow meter, 4m delivery hose and an automatic nozzle. Easily mountable next to a bulk diesel tank or onto service trucks, this kit is the perfect solution for high flow or high volume diesel transfer.



60LPM
AHFP12A

12V High flow Automatic Diesel Pump Kit

The pump kit is designed to reliably transfer diesel (only). The pump is a self priming, positive displacement, rotary vane pump operating on 12V DC. The pump will deliver up to 85 litres per minute, has a built-in bypass valve. The motor has a 30 minute duty cycle. The pumps are supplied complete with everything needed for the operator to start transferring diesel. For the best control and accuracy, it is recommended to use the appropriate Macnaught digital diesel meter and filter.



85LPM
AHFP85L-12A

Why choose this product?

Premium high flow electric 12 volt diesel pump kit, supplied with accurate mechanical flow meter, auto nozzle, and wall mount plate, ideal for remote mounting to service trucks or similar use.

Why choose this product?

Premium high flow electric 12 volt diesel pump kit, supplied with accurate mechanical flow meter, auto nozzle, and wall mount plate, ideal for remote mounting to service trucks or similar use.

Part Number	AHFP12A
Description	12V High Flow Wall Mount Diesel Pump Kit
Flow range	60L/min (16gal/min)
Volt	12V
Inlet/ Outlet	1" BSPP (F)
Nozzle	Automatic
Duty Cycle	30 Min
Suction hose	25mm (1") x 2m (6.5ft)
Delivery hose	19mm (3/4") x 4m (13ft)
Suitable fluids	*Suitable for diesel use only
Meter included	✓
Wall mount	✓

Applications:

Ideal for use for any diesel transfer applications

Recommended to be used with:



ADTFM Digital Fuel Meter



ATS205 Telescopic Suction Tube

Service Parts for AHFP12A

- AHFP12A-1K: Pump Service Parts
- AHFP12A-2K: Poppet Valve Kit
- AHF-SWITCH: On/Off Switch

Part Number	AHFP85L-12A
Description	12V High Flow Automatic Diesel Pump Kit
Flow range	85L/min (22.5gal/min)
Volt	12V
Inlet/ Outlet	1" BSP (F)
Nozzle	Automatic
Duty Cycle	30 Min
Suction hose	25mm (1") x 2m (6.5ft)
Delivery hose	25mm (1") x 4m (13ft)
Suitable fluids	*Suitable for diesel use only
Meter included	x
Wall mount	x

Applications:

Ideal for use for any diesel transfer applications

Recommended to be used with:



ADTFM Digital Fuel Meter



ATS205 Telescopic Suction Tube

Service Parts for AHFP85L-12A

- AHFP85L-1K: Pump Service Parts

ELECTRIC FUEL PUMPS

240V High Flow Diesel Pumps

Macnaught offers a range of 240V HIGH FLOW DIESEL PUMPS. These self-priming rotary vane pumps are equipped with a fan cooled motor, built-in bypass valve, stainless steel filter and a cast iron body with anti-corrosion coating. These sturdy pumps ensure reliability and a long service life.



240V heavy duty pump
Heavy duty construction for long life and reliability

Self priming
Instant reliable delivery



70LPM
AHFP70LPM

Fan cooled
Prevents Overheating

Ready to use
Supplied with electric cable and 240V plug

150LPM
AHFP150LPM

100LPM
AHFP100LPM

Why choose this product?

Quality range of high flow 240Volt electric diesel pumps, ideal for all types of diesel transfer applications.

Part Number	AHFP70LPM	AHFP100LPM	AHFP150LPM
Description	240V High Flow Diesel Pump 70LPM	240V High Flow Diesel Pump 100LPM	240V High Flow Diesel Pump 150LPM
Flow range	70L/min (18.5gal/min)	100L/min (26gal/min)	150L/min (40gal/min)
Volt	240V	240V	240V
Inlet/ Outlet	1" BSPP (F)	1" BSPP (F)	1" BSPP (F)
Max current draw	2.3 Amps with IP55 motor protection	4.1 Amps with IP55 motor protection	14.5 Amps with IP55 motor protection
Duty Cycle	Continuous	30min	30min
Suitable fluids	*Suitable for diesel use only		

Service Parts for AHFP70LPM

- AHFP70LPM-1K: Wet Seal Kit
- AHFP70LPM-2K: Poppet Valve Kit
- AHF70LPM-CAP: Capacitor
- AHF-SWITCH: On/Off Switch

Service Parts for AHFP100LPM

- AHFP100LPM-1K: Wet Seal Kit
- AHFP100LPM-2K: Poppet Valve Kit
- AHF100LPM-CAP: Capacitor
- AHF-SWITCH: On/Off Switch

Service Parts for AHFP150LPM

- AHFP100LPM-1K: Wet Seal Kit
- AHFP100LPM-2K: Poppet Valve Kit
- AHF100LPM-CAP: Capacitor
- AHF-SWITCH: On/Off Switch

Recommended to be used with:



ADTFM
Digital Fuel Meter



ATS205
Telescopic Suction
Tube



AMFM (for 70 &
100LPM models)
Mechanical Fuel Meter

Applications:

Ideal for use for any diesel transfer applications

240V Diesel Mini Bowser

The Macnaught range of 240V Diesel Mini Bowsers offer the operator new options when looking for robust construction that deliver consistently higher flow rates. These compact units come as complete packages that allow delivery rates up to 100 L/min. Equipped with easy to use, accurate mechanical register that can be calibrated on-site, these units also offer smart on/off switches integrated into the nozzle holder. Extremely versatile, the bowsers can be installed directly to the wall or any suitable structure.



Resettable fill totaliser
4-digit resettable

Non-resettable accumulative totaliser
8-digit accumulative total

Hose hanger
Allows for neat hose storage



Automatic nozzle
with delivery hose

Built-in on/off switch
Pump protection from overheating

Long fuel hose
Long hose provides access to hard to reach fuel fill points

Service Parts for AMB100L

- AHFP100LPM-1K: Wet Seal Kit
- AHFP100LPM-2K: Poppet Valve Kit
- AHF100LPM-CAP: Capacitor
- AHF-SWITCH: On/Off Switch

Service Parts for AMB60L

- AHFP70LPM-1K: Wet Seal Kit
- AHFP70LPM-2K: Poppet Valve Kit
- AHF70LPM-CAP: Capacitor
- AHF-SWITCH: On/Off Switch

Why choose this product?

Complete diesel dispensing unit, ideal for high use applications. The built in meter provides accurate recording of fuel usage, with the use of a micro switch the pump will switch off when nozzle is replaced into holder.

Part Number	AMB100L	AMB100L-6M	AMB60L
Description	240V Diesel Mini Bowser - 100L	240V Diesel Mini Bowser - 100L 6m hose	240V Diesel Mini Bowser - 60L
Flow range	100L/min (26gal/min)	100L/min (26gal/min)	60L/min (16gal/min)
Volt	240V	240V	240V
Inlet/ Outlet	1" BSP (F)	1" BSP (F)	1" BSP (F)
Nozzle	Automatic	Automatic	Automatic
Hose length	4 metres	6 metres	4 metres
Duty Cycle	30 Min	30 Min	30 Min
Suction hose	25mm (1") x 2m (6.5ft)	25mm (1") x 2m (6.5ft)	25mm (1") x 2m (6.5ft)
Delivery hose	25mm (1") x 4m (13ft)	25mm (1") x 6m (19.6ft)	25mm (1") x 4m (13ft)
Suitable fluids	*Suitable for diesel use only		

AIR OPERATED DIAPHRAGM PUMPS



Air Operated Diaphragm Pumps

Heavy duty yet lightweight and easy to operate, these diaphragm pumps are designed to provide continuous flow. These double diaphragm air operated pumps offer a great solution for clean and dirty liquids, particularly waste oils, as they are particle tolerant. These pumps are compatible with oils (new & used), engine coolants RTU (new & used), oily water and diesel.

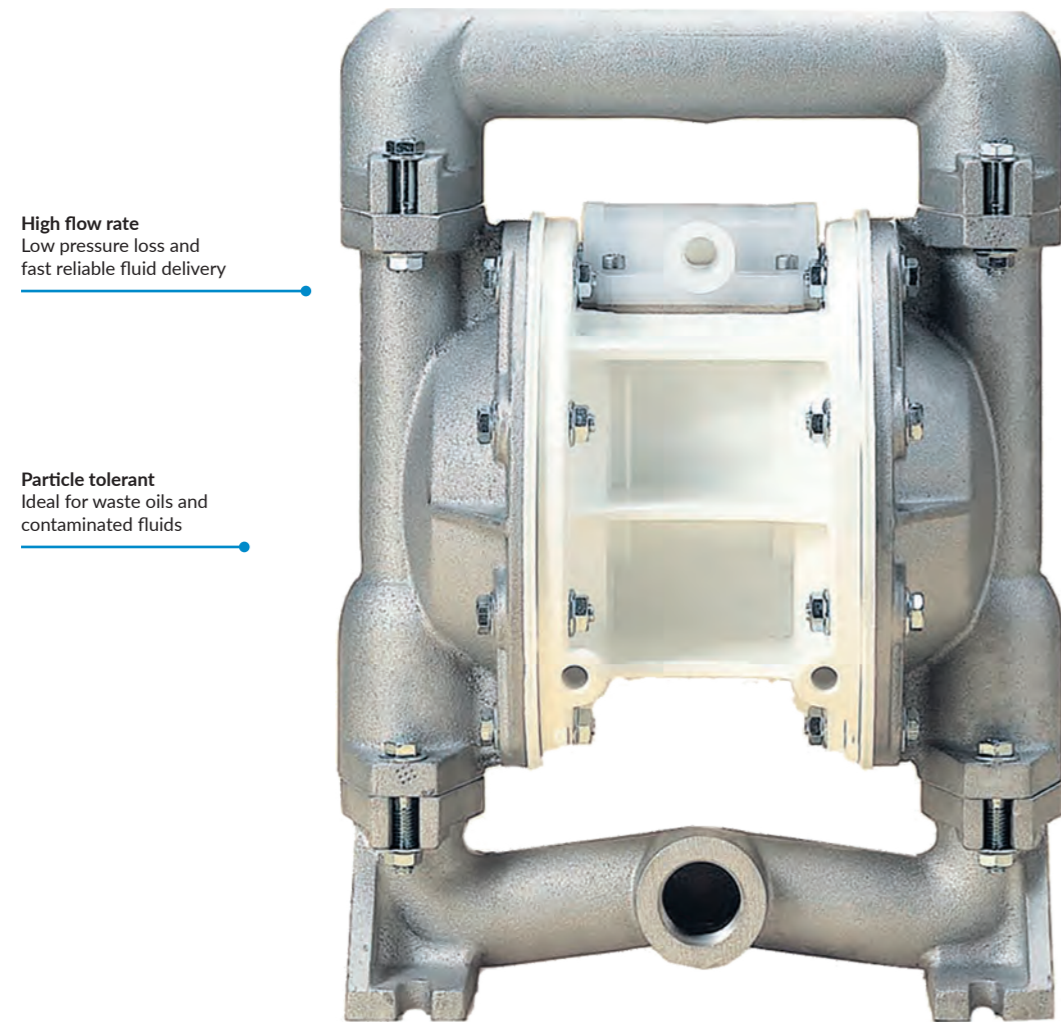

High flow rate
Low pressure loss and fast reliable fluid delivery

Particle tolerant
Ideal for waste oils and contaminated fluids

Heavy duty construction
Long life and reliability

Exhaust muffler
To reduce noise level

Service Parts available
For peace of mind

DDP19

Air Operated Diaphragm Pumps

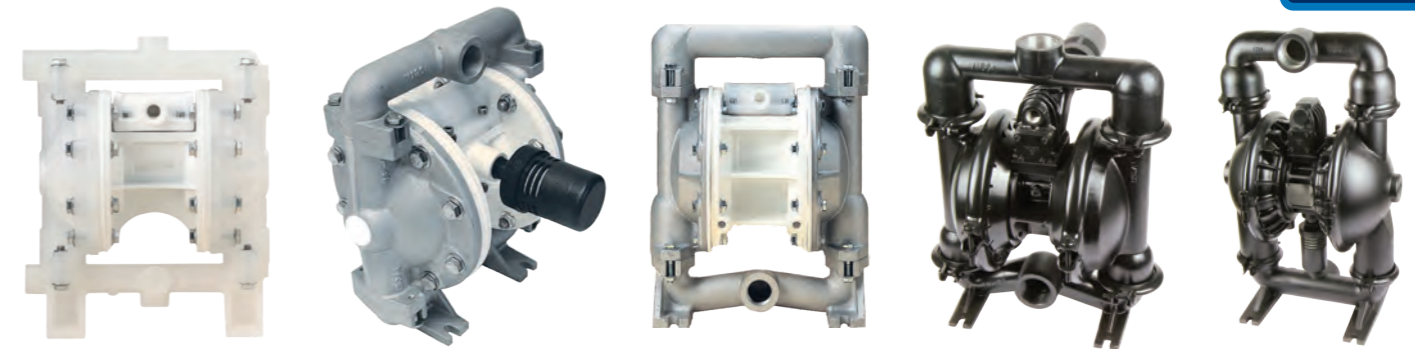

DDP13

DDP19

DDP25

DDP38

DDP50

Part Number	DDP13	DDP19	DDP25	DDP38	DDP50
Description	1/2" Diaphragm Pump	3/4" Diaphragm Pump	1" Diaphragm Pump	1 1/2" Diaphragm Pump	2" Diaphragm Pump
Max air pressure	100psi (690kPa)	100psi (690kPa)	100psi (690kPa)	100psi (690kPa)	100psi (690kPa)
Inlet/outlet	1/2" NPT (F)	3/4" NPT (F)	1" BSP (F)	1 1/2" BSP (F) / 1 1/4" BSP (F)	2" BSP (F)
Air inlet	3/8" NPT (F)	3/8" NPT (F)	1/2" NPT (F)	1/2" NPT (F)	1/2" NPT (F)
Max flow rate	42L/min (11gal/min)	45L/min (11.9gal/min)	174L/min (46gal/min)	265L/min (70gal/min (viscosity dependent))	598L/min (158gal/min (viscosity dependent))
Suction lift	3.6m (12ft) (dry) 9.1m (30ft) (wet)	3.9m (12.8ft) (dry) 6.7m (22ft) (wet)	4.9m (16ft) (dry) 9.4m (31ft) (wet)	4.6m (15ft) (dry) 7.6m (25ft) (wet)	5.2m (17ft) (dry) 9.8m (32ft) (wet)
Max solids handling	1.6mm (0.0625")	1.6mm (0.0625")	3.2mm (0.125")	4.76mm (0.188")	6.4mm (0.25")
Fluid temperature	0°C - 82°C (32°F - 180°F)	*-23°C - + 88°C (-9.4°F - 190°F)	*-23°C - + 88°C (-9.4°F - 190°F)	*-12°C - + 82°C (10°F - 180°F)	*-12°C - + 82°C (10°F - 180°F)
Max noise level	86 dB(A)	84 dB(A)	93 dB(A)	77 dB(A)	96 dB(A)
Suitable fluids	*Suitable for oils (new & used), engine coolants RTU (new & used), oily water and diesel				
Wetted Parts	Polypropylene (body & valve seats), Buna N (diaphragms), acetal (check valves)		Aluminium/Polypropylene (body), aluminium (valve seats), Buna N (diaphragms), acetal (check valves)		Cast aluminium (body), Buna N (valve seats, diaphragms, check valves)

Service Parts (For DDP13 & DDP19)

- L-E505BN: Diaphragm
- L-E5P BN/A KIT: Wet End Kit
- L-E5AV KIT: Air End Kit
- L-E5PV KIT: Pilot Valve Kit
- L-VTM-3: Muffler

Service Parts (For DDP25)

- L-V183BN-1: Diaphragm
- L-V1.0 BN/A Kit: Wet End Kit
- L-E1P AV KIT: Air Valve Kit
- L-VTM-4: Muffler
- L-E1P PV Kit: Pilot Valve Kit

Service Parts (For DDP38)

- DRV1.25BNKIT: Wet side rebuild
- E4AAVKIT: Air valve kit
- E4PVKIT: Pilot Valve kit

Service Parts (For DDP50)

- L-VTM-5: Exhaust Muffler
- V224BN: Diaphragm Repair Kit
- V2.0-BN-Kit: Fluid Repair Kit

Why choose this product?

Ideal for the efficient transfer of diesel, new and waste oils, as well as most contaminated automotive fluids.

Applications:

Automotive, Truck and Buses, Farming, Construction and Earthmoving, Military, Mining, Aircraft, Trains

Recommended to be used with:



FUEL EQUIPMENT SYSTEMS

Poly Diesel Tanks

The Macnaught Poly Tanks are the only portable diesel tanks on the Australian market to not only offer a 15 year warranty on the tank but a full 5 year warranty on the pump unit. Assembled using the highest quality, specially formulated polyethylene to withstand the harshest conditions, they offer lightweight yet sturdy fuel storage solutions. Designed with numerous safety features including auto shut-off nozzles to prevent fuel wastage, an earth strap to prevent the build-up of static electricity when the tank is in use and 3 lock security points. Together, these features provide the operator with peace of mind when refuelling.



Premium Quality 12V Fuel Pump
Automatic Nozzle 12V Electric fuel pump for reliable diesel fuel delivery

Streamline compact design
Ideal for mounting to Ute and service trucks

Heavy duty Polyethylene Tank construction
Lightweight and very strong with 15 years warranty

3 point lockable security
3 point security (lockable lid, nozzle and fuel cap) which ensures peace of mind

Automatic nozzle
Prevent fuel waste or spillage

MDT300L



Baffles included*

*Baffles included on MDT1000L and MDT1200L models only

Why choose this product?

The poly diesel tanks are designed to withstand the harshest conditions. The lightweight tank with built in safety features and reliable premium quality diesel pump gives the operator peace of mind when refueling is required.

Recommended to be used with:



ADTFM Digital Meter

Applications:

Ideal addition to the back of a Service truck, Ute or portable diesel fuel system.

Macnaught 12V Electric Diesel Pump Kit

Extra-long 4m (13ft) hose

Flow rates up to 85LPM



30 minute duty cycle

Lockable lid to prevent fuel theft

Self priming - trouble free operation

12V Electric Diesel Pumps

The Macnaught Poly Tanks come fitted with a 12V diesel pump capable of delivering 40LPM/ 85LPM dependent on model. (Tank kit and Pump model specified below)



12V ELECTRIC DIESEL PUMP KIT AUTOMATIC NOZZLE - 40LPM
AFP12A



Available in the following models

- MDT100L
- MDT200L
- MDT300L
- MDT400L
- MDTN400L
- MDT600L

12V HIGH FLOW ELECTRIC DIESEL PUMP KIT AUTOMATIC NOZZLE - 85LPM
AHFP85L-12A



Available in the following models

- MDT800L
- MDT1000L (baffles included)
- MDT1200L (baffles included)

FUEL EQUIPMENT SYSTEMS



Poly Diesel Tank Kit Range

Why choose this product?

The poly diesel tanks are designed to withstand the harshest conditions. The lightweight tank with built in safety features and reliable premium quality diesel pump gives the operator peace of mind when refueling is required.



Features & Benefits

- 12V Electric pump kit
- Built-in suction hose
- Automatic nozzle
- 3 point security (lockable lid, nozzle and fill cap)
- Bucket strainer
- Earthing cable
- Moulded carry handles



Part Number	MDT100L	MDT200L	MDT300L	MDT400L	MDTN400L	MDT600L	MDT800L	MDT1000L	MDT1200L
Description	100L Diesel Tank with 12V Pump Kit - 40L/min	200L Diesel Tank with 12V Pump Kit - 40L/min	300L Diesel Tank with 12V Pump Kit - 40L/min	400L Diesel Tank with 12V Pump Kit - 40L/min	400L Narrow Diesel Tank with 12V Pump Kit - 40L/min	600L Diesel Tank with 12V Pump Kit - 40L/min	800L Diesel Tank with High Flow 12V Pump - 85L/min	1000L Diesel Tank with High Flow 12V Pump - 85L/min	1200L Diesel Tank with High Flow 12V Pump - 85L/min
Flow rate	Up to 40L/min (11gal/min)	Up to 40L/min (11gal/min)	Up to 40L/min (11gal/min)	Up to 40L/min (11gal/min)	Up to 40L/min (11gal/min)	Up to 40L/min (11gal/min)	Up to 85L/min (22.5gal/min)	Up to 85L/min (22.5gal/min)	Up to 85L/min (22.5gal/min)
Electric pump kit	12V Electric diesel pump kit				12V Electric diesel pump kit				
Capacity	100L (26gal)	200L (53gal)	300L (79gal)	400L (106gal)	400L (106gal)	600L (158gal)	800L (211gal)	1000L (264gal)	1200L (317gal)
Nozzle	Automatic	Automatic	Automatic	Automatic	Automatic	Automatic	Automatic	Automatic	Automatic
3 point security (lockable lid, nozzle and fill cap)	✓	✓	✓	✓	✓	✓	✓	✓	✓
Bucket Strainer	✓	✓	✓	✓	✓	✓	✓	✓	✓
Built-in suction hose	✓	✓	✓	✓	✓	✓	✓	✓	✓
Delivery hose	19mm (3/4") x 4m (13ft)	19mm (3/4") x 4m (13ft)	19mm (3/4") x 4m (13ft)	19mm (3/4") x 4m (13ft)	19mm (3/4") x 4m (13ft)	19mm (3/4") x 4m (13ft)	25mm (1") x 4m (13ft)	25mm (1") x 4m (13ft)	25mm (1") x 4m (13ft)
Earthing cable	✓	✓	✓	✓	✓	✓	✓	✓	✓
Moulded carry handles	✓	✓	✓	✓	✓	✓	✓	✓	✓
Dimensions	800L x 680W x 465H	800L x 680W x 710H	1290L x 600W x 770H	1150L x 820W x 780H	1290L x 600W x 965H	1700L x 880W x 740H	1700L x 1000W x 860H	1700L x 1000W x 1025H	1700L x 1000W x 1190H
Suitable Fluids	Suitable for diesel				Suitable for diesel				
Warranty¹	15 years (tank) 5 years (pump)	15 years (tank) 5 years (pump)	15 years (tank) 5 years (pump)	15 years (tank) 5 years (pump)	15 years (tank) 5 years (pump)	15 years (tank) 5 years (pump)	15 years (tank) 5 years (pump)	15 years (tank) 5 years (pump)	15 years (tank) 5 years (pump)

Note¹: 15 years warranty on tanks, 5 years warranty on pumps. Subject to Macnaught warranty terms and conditions, see www.macnaught.com.au/warranty.

MECHANICAL FUEL METERS

In-line fuel meters

These positive displacement fuel meters are ideal for use with electric diesel pumps, remote field and in-line use. Macnaught Mechanical Fuel Meters provide reliable and accurate measurement of liquid without the need for power or batteries.



Gravity Fed systems
Low pressure drop for use with gravity fed systems



DM100-01

Rotatable Face
Register Cap is rotatable for easy display

Solid Body
Robust aluminium meter body

Meter Technology
Oval Gear technology with mechanical register for high accuracy

Calibration
No field calibration needed

Rotatable Face
Register can be rotated up to 180° for easy display

Nutating Disc

Calibration screw
For easy field calibration



AMFM



DIGITAL FUEL METERS



In-line fuel meters

The Macnaught Digital Turbine meters are compact, lightweight and accurate and are ideal for use on gravity or in-line applications, or with an automatic fuel nozzle. The meters have a field calibration accuracy of +/- 0.5%. The electronic display can be rotated 180°C and contains a built in computer with many useful additional features listed below.



ADTFM

Rotatable Face
Register can be rotated up to 180° for easy display

Field calibration capability

Solid Body
Robust aluminium meter body

Meter Technology
Oval Gear technology with mechanical register for high accuracy



ADTUM

Why choose this product?

Turbine meter provides reliable accurate measurement

Part Number	ADTFM	ADTUM
Description	Digital Diesel Meter	Digital Urea/DEF Meter
Flow range	10 - 150L/min (2.6 - 40gal/min)	10 - 150L/min (2.6 - 40gal/min)
Meter/ register	Electronic	Electronic
Accuracy	+/- 0.5%	+/- 0.5%
Features	6-digit reset total 6-digit non-reset total	6-digit reset total 6-digit non-reset total
Max working pressure	50psi (3.5bar)	50psi (3.5bar)
Inlet port	1" BSP	1" BSP
Outlet port	1" BSP	1" BSP
Compatible fluids	Suitable for diesel, kerosene and coolants	Suitable for UREA/DEF and water

Recommended to be used with:

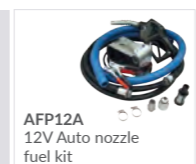

Why choose this product?

Meter oval gear provides accurate measurement.

Part Number	DM100-01	AMFM
Description	Mechanical Fuel Meter	Mechanical Diesel Meter
Flow range	3 - 80L/min (0.8 - 21gal/min)	20 - 120L/min (5 - 31gal/min)
Meter / register	Oval gear / Mechanical	Mechanical
Accuracy (flow rate)	+/- 1%	+/- 1% of reading when field calibrated
Features	Low pressure drop makes this meter suitable for gravity fed systems register cap is rotatable for easy display mesh strainer included	4-digit resettable total 8-digit non-resettable total Register can be rotated (180 degrees)
Inlet port	1" BSP (F)	1" BSP (F)
Outlet port	1" BSP (F)	1" BSP (F)
Compatible fluids	Diesel, kerosene, light oils and petrol	Suitable for diesel, kerosene and light oils
Max working pressure	50psi (3.5bar)	50psi (3.5bar)
Min/Max working Temp	-5° to 80°C (23°F-176°F)	"-26°C (-15 °F) to +66°C (150°F)
Warranty	10 years	5 years

Recommended to be used with:

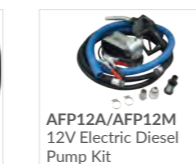
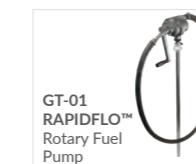
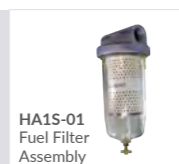

Service Parts for DM100-01
• DM100-1K Seal Kit

INDUSTRIAL FLOW METERS

Macnaught Industrial Flow Meters

As the global oval gear flow meter technology leader with over 50 years experience, Macnaught offers two comprehensive product ranges that solve a number of challenging flow conditions. These Australian manufactured meters are all tested and are supplied with a calibration certificate.

The MX-SERIES is the latest innovation featuring:

- High precision billet constructions for enhanced material integrity & process reliability
- Programmable digital display & pulse output options
- Unique bayonet assembly for added versatility & flexibility



The M-SERIES is Macnaught's original range featuring:

- Established design & cast construction for proven performance
- Mechanical & pulse output options



Advantages

- Models available to suit a wide range of fluids
- Oval gear technology delivers high accuracy +/- 0.5% & repeatability of +/- 0.03%
- Flow ranges from 0.5 L/min to 1200 L/min in sizes 1/4" to 4"
- Suitable for viscous fluids
- Low cost of ownership
- Industry leading supply turnaround
- Accuracy unaffected by changes in viscosity
- Minimal maintenance required
- Ease of installation - no flow conditioning required
- Compact overall lay length means no support issues & superior design capabilities over alternative flow devices
- Exceptional turn down ratio

Applications

Flow meters are available to suit all industry types and most applications. The Macnaught industrial range of meters are specifically manufactured to suit your specific individual requirements.

	MX-Series	M-Series
Materials of construction	Billet construction, Stainless Steel, Aluminium	Cast construction, Stainless Steel, Aluminium, PPS
Process Connection	BSP, NPT, ANSI Class 150, JIS, 10K, DIN PN16	
Output	Standard Pulse, Intrinsically Safe Pulse, High Temp. Pulse 4 - 20mA output	Standard Pulse, Standard Mechanical Register, Heavy Duty Mechanical Register

	Flow Ranges		Turndown Ratio
1/4"	0.13 - 26 GPH	0.5 - 100 L/hr	200 : 1
1/4"	4 - 132 GPH	15 - 500 L/hr	33 : 1
1/2"	0.5 - 8 GPM	2 - 30 L/min	15 : 1
3/4"	0.8 - 21 GPM	3 - 80 L/min	26 : 1
1"	1.6 - 32 GPM	6 - 120 L/min	20 : 1
1 1/2"	2.6 - 66 GPM	10 - 250 L/min	25 : 1
2"	4 - 130 GPM	15 - 500 L/min	33 : 1
3"	5 - 194 GPM	20 - 733 L/min	36 : 1
4"	31.7 - 317 GPM	120 - 1200 L/min	10 : 1

For more information, please contact your local Macnaught Representative or contact us at flowmeters@macnaught.com
www.macnaughtflowmeasurement.com.au

High precision instruments ideal for use in the following applications:

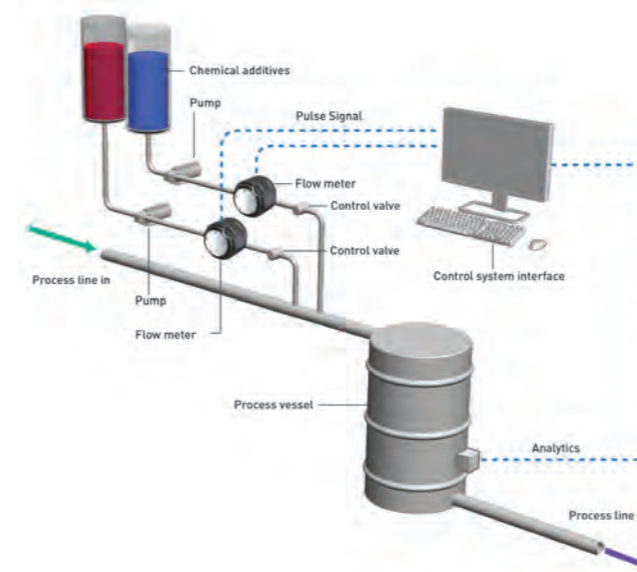

BATCHING

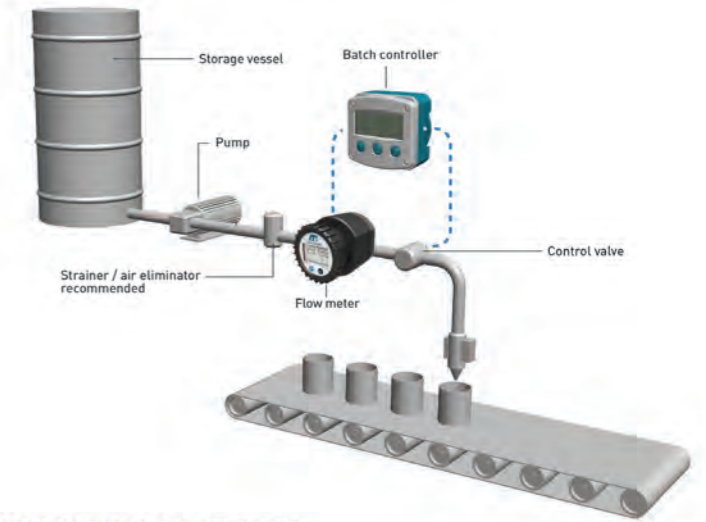

FUEL CONSUMPTION

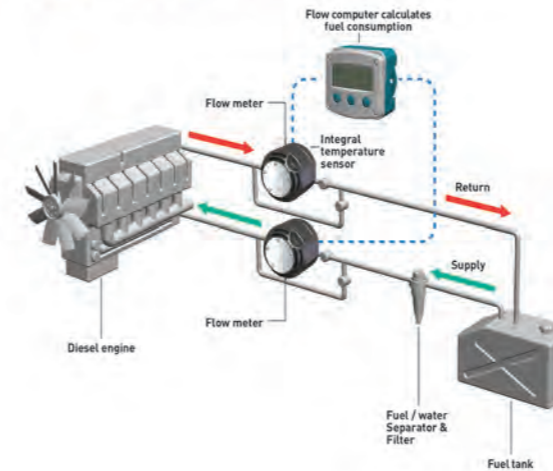

BULK FUEL TRANSFER

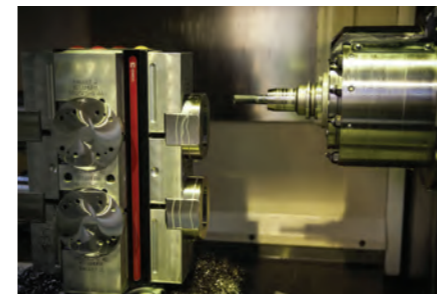
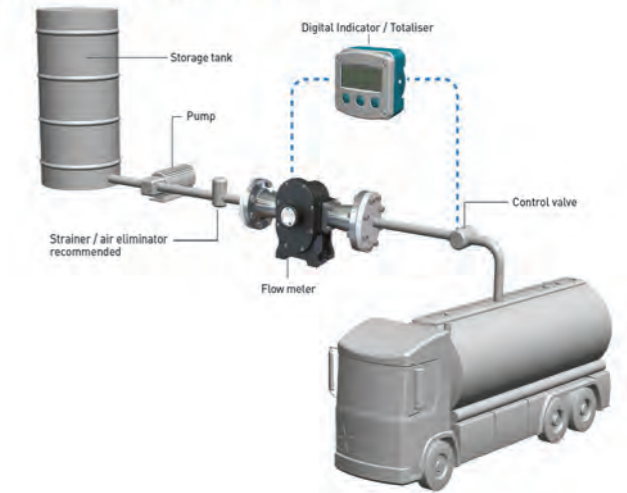

FUEL ACCESSORIES

GREASE HOSE REELS



**FUEL FILTER KIT
HA-01**
Fuel filter kit to suit LITRESTROKE™ pump. Includes 10µm filter and fittings to connect to pump. Max pressure: 150psi



**FUEL FILTER ASSEMBLY
HA1S-01**
10µm fuel filter – 1" BSP. Uses 10µm replacement filter elements. Max pressure: 150psi



**FUEL FILTER ASSEMBLY
HA1SS80**
80 MESH – 1" BSP (F) ports. Uses 80MESH stainless steel strainer for more contaminated applications. Max pressure: 150psi



**FUEL FILTER KIT
VA-01**
Fuel filter kit to suit RAPIDFLO™ RVP and GT pumps. Includes 10µm filter and fittings to connect to pump. Max pressure: 150psi.



**STAINLESS STEEL STRAINER
HASS40S**
40 MESH replacement element
HASS80S
80 MESH replacement element



**REPLACEMENT FUEL FILTER
HA7S**
Replacement 10µm fuel filter element to fit GB, HA, VA and HA1S filters.



**BUNG ADAPTOR - 2" BSP
AC26**
Blue bung adaptor 2" BSP (F) - 2" (M) Mouser
AC27
Orange bung adaptor 2" BSP (F) - 2" (M) Tri-Sure
AC28
Yellow bung adaptor 2" BSP (F) - Din 61 (F)



**FITTINGS KIT FOR HP-01
DH-01**
Fittings kit for connecting DM100/150 meters to LITRESTROKE™ pumps



**FITTINGS KIT FOR GT-01
DV-01**
Fittings kit for connecting DM100/150 meters to RAPIDFLO™ pumps



**NOZZLE FOR DIESEL/ULP FUELS
HNU**
Nozzle for diesel/ULP fuels. For use with HP or GT pumps



**TELESCOPIC SUCTION TUBE
TB25S**
Telescopic suction tube: 1" BSP (M), length 615 - 1035mm (24" - 40"). Suitable for oil and diesel.



**TELESCOPIC SUCTION TUBE WITH STRAINER
ATS205**
Designed for use with the Macnaught range of electric fuel pumps when used to pump out of 205L containers. The 2" sliding bung adaptor has a 3/4" BSP (M) thread connection. Closed length is 590mm and open length is 1030mm.

Grease Reels - Single Pedestal Models

The Macnaught range of heavy duty Reels are designed and manufactured using the highest quality materials and finish that guarantee reliability and durability. The reels are ideal for use in wide range of applications and can be fitted in a variety of positions such as Wall, floor, tank, truck or overhead.



Adjustable guide arms and variable roller guide direction for versatility

Heavy duty powder coated steel construction

Fitted with heavy duty hose

Heavy duty steel spring enclosure for safety and reliability

Fully serviceable

MGS0615-01

Part Number	MGS0615-01
Description	Single Pedestal Grease Reel 6mm x 15m
Reel Type	Single Pedestal
Application	Grease
Hose Size (ID)	6mm (1/4")
Working Pressure	34, 500kPa (5000 psi)
Hose Material	Steel Wire Braided Rubber
Reel Inlet	1/4" BSP(F)
Hose Outlet	1/4" BSP(M)
Hose Length	15m (50 ft)

Applications:

All models are ideal for use in all workshop applications. The range of twin pedestal reels are also suitable for off road service vehicle applications.

Recommended to be used with:

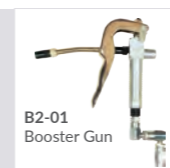

GREASE HOSE REELS

Grease Reels - Twin Pedestal Models

The Macnaught range of heavy duty Reels are designed and manufactured using the highest quality materials and finish that guarantee reliability and durability. The reels are ideal for use in wide range of applications and can be fitted in a variety of positions such as Wall, floor, tank, truck or overhead.



Part Number	MGTP0615-01	MGTP0915-01
Description	Twin Pedestal Grease Reel 6mm x 15m	Twin Pedestal Grease Reel 10mm x 15m
Reel Type	Twin Pedestal	Twin Pedestal
Application	Grease	Grease
Hose Size (ID)	6mm (1/4")	10mm (3/8")
Working Pressure	34, 500kPa (5000 psi)	34, 500kPa (5000 psi)
Hose Material	Steel Wire Braided Rubber	Steel Wire Braided Rubber
Reel Inlet	1/4" BSP(F)	3/8" BSP(F)
Hose Outlet	1/4" BSP(M)	3/8" BSP(M)
Hose Length	15m (50 ft)	15m (50 ft)

Applications:

All models are Ideal for use in all workshop applications. The range of twin pedestal reels are also suitable for off road service vehicle applications.

Recommended to be used with:

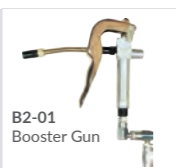

OIL/DIESEL HOSE REELS



Oil/Diesel Reels - Single and Twin Pedestal Models

The Macnaught range of heavy duty Reels are designed and manufactured using the highest quality materials and finish that guarantee reliability and durability. The reels are ideal for use in wide range of applications and can be fitted in a variety of positions such as Wall, floor, tank, truck or overhead..

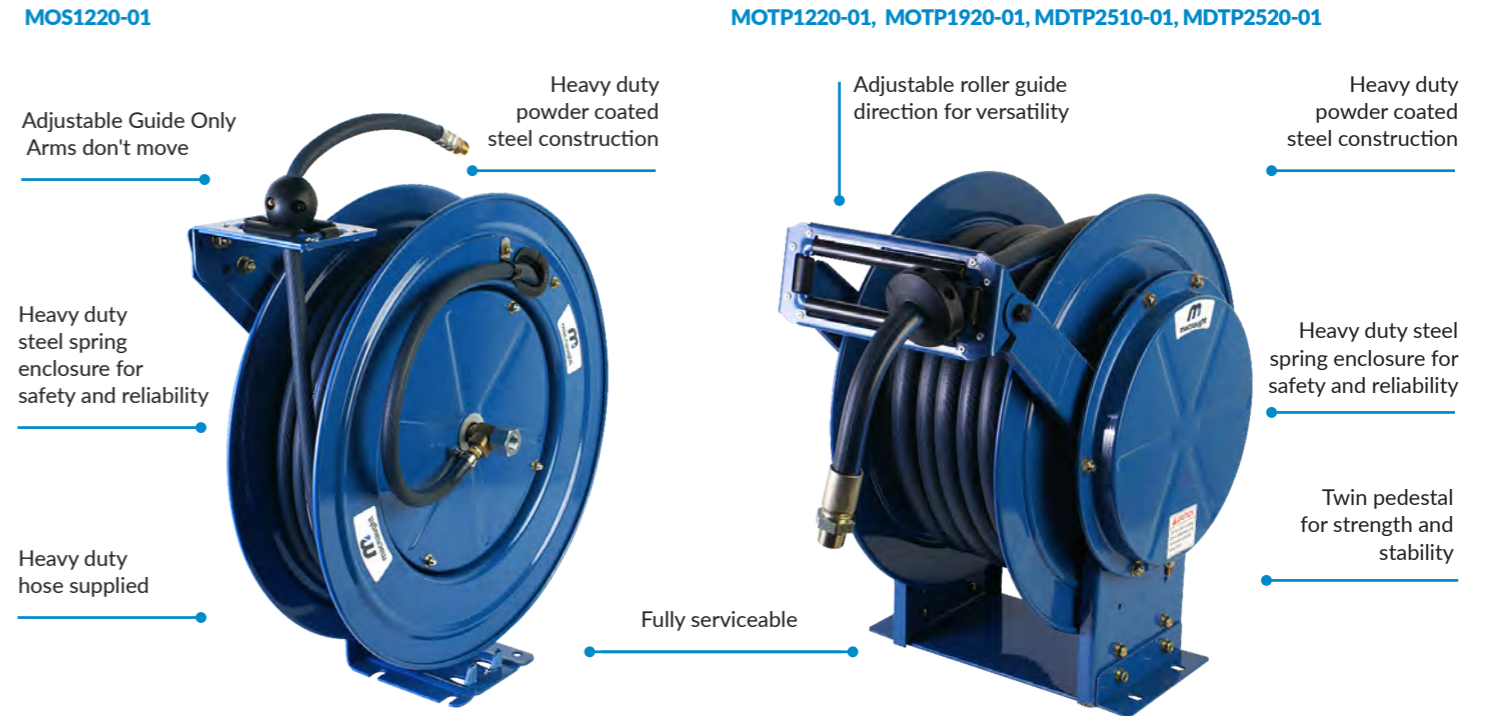

Part Number	MOS1220-01	MOTP1215-01	MOTP1220-01	MOTP1920-01	MDTP2510-01	MDTP2520-01
Description	Oil Reel 12mm x 20m	Oil Reel 12mm x 15m	Oil Reel 12mm x 20m	Oil Reel 19mm x 20m	Diesel/Oil Reel 25mm x 10m	Diesel/Oil Reel 25mm x 20m
Reel Type	Single Pedestal	Twin Pedestal (Low roller)	Twin Pedestal	Twin Pedestal	Twin Pedestal	Twin Pedestal
Application	Oil	Oil	Oil	Diesel/Oil	Diesel/Oil	Diesel/Oil
Hose Size (ID)	12mm (1/2")	12mm (1/2")	12mm (1/2")	19mm (3/4")	25mm (1")	25mm (1")
Working Pressure	13, 800kPa (2, 000 psi)	13, 800kPa (2, 000 psi)	13, 800kPa (2, 000 psi)	8, 600kPa (1, 250psi)	3, 500kPa (500psi)	3, 500kPa (500psi)
Hose Material	Steel Wire Braided Rubber	Steel Wire Braided Rubber	Steel Wire Braided Rubber	Steel Wire Braided Rubber	Steel Wire Braided Rubber	Steel Wire Braided Rubber
Reel Inlet	1/2" BSP(F)	1/2" BSP(F)	1/2" BSP(F)	3/4" BSP(F)	1" BSP(F)	1" BSP(F)
Hose Outlet	1/2" BSP(M)	1/2" BSP(M)	1/2" BSP(M)	3/4" BSP(M)	1" BSP(M)	1" BSP(M)
Hose Length	20m (65ft)	15m (50 ft)	20m (65ft)	20m (65ft)	10m (33ft)	20m (65ft)

Applications:

All models are Ideal for use in all workshop applications. The range of twin pedestal reels are also suitable for off road service vehicle applications.

Recommended to be used with:

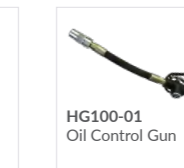
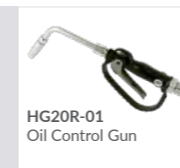

HOSE REELS



Air/Water Reels - Single and Twin Pedestal Models

The Macnaught heavy duty Reels are designed and manufactured using the highest quality materials and finish that guarantee reliability and durability. The reels are ideal for use in wide range of applications and can be fitted in a variety of positions such as Wall, floor, tank, truck or overhead.



MAS1020-01, MAS1220-01

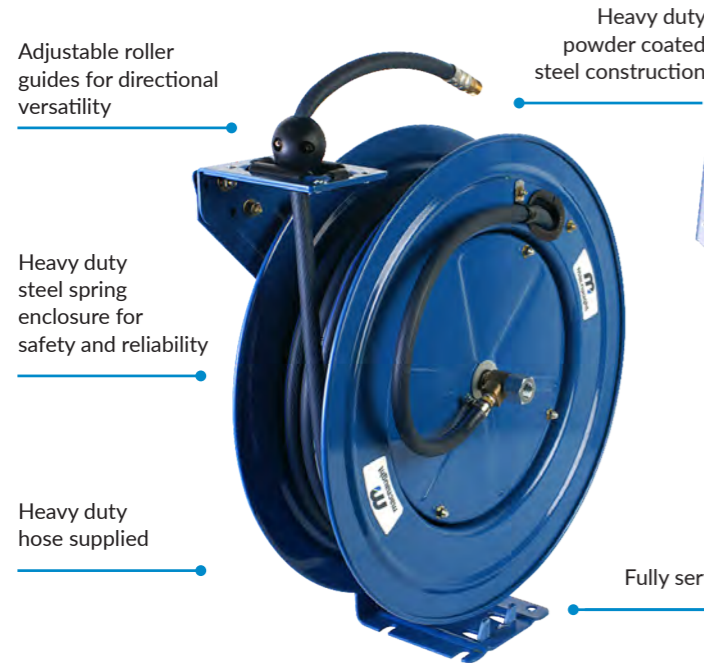

MATP1220-01, MATP1920-01

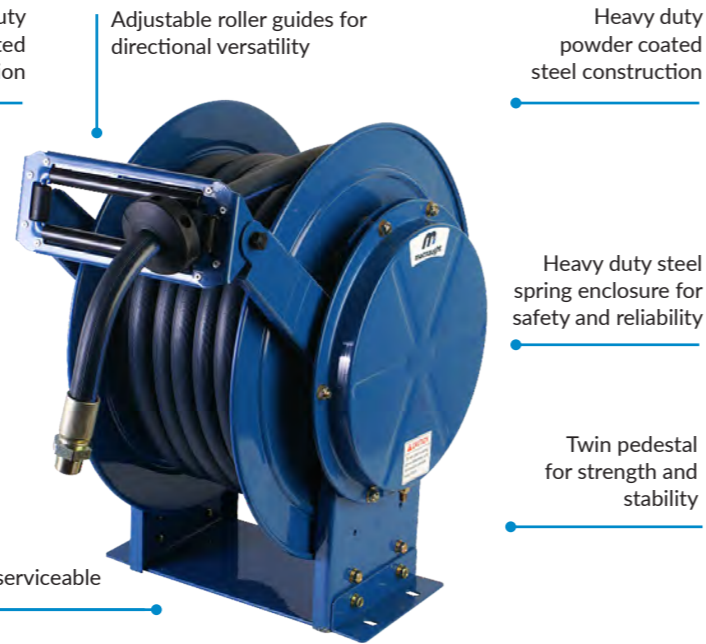

Part Number	MAS1020-01	MAS1220-01	MATP1220-01	MATP1920-01
Description	Air/Water Single Pedestal Reel 10mm x 20m	Air/Water Single Pedestal Reel 12mm x 20m	Air/Water Twin Pedestal Reel 12mm x 20m	Air/Water Twin Pedestal Reel 19mm x 20m
Reel Type	Single Pedestal	Single Pedestal	Twin Pedestal	Twin Pedestal
Application	Air/Water	Air/Water	Air/Water	Air/Water
Hose Size (ID)	10mm (3/8")	12mm (1/2")	12mm (1/2")	19mm (3/4")
Working Pressure	2, 100kPa (300psi)	2, 100kPa (300psi)	2, 100kPa (300psi)	2, 100kPa (300psi)
Hose Material	Synthetic Rubber	Synthetic Rubber	Synthetic Rubber	Synthetic Rubber
Reel Inlet	3/8" BSP(F)	1/2" BSP(F)	1/2" BSP(F)	3/4" BSP(F)
Hose Outlet	3/8" BSP(M)	1/2" BSP(M)	1/2" BSP(M)	3/4" BSP(M)
Hose Length	20m (65ft)	20m (65ft)	20m (65ft)	20m (65ft)

Applications:

All models are Ideal for use in all workshop applications. The range of twin pedestal reels are also suitable for off road service vehicle applications.

Recommended to be used with:



CCG-01 Coolant Control Nozzlet

HOSE REELS

Bare Reels - Single and Twin Pedestal Models

The Macnaught heavy duty Reels are designed and manufactured using the highest quality materials and finish that guarantee reliability and durability. The reels are ideal for use in wide range of applications and can be fitted in a variety of positions such as Wall, floor, tank, truck or overhead.



MRS1320N-01

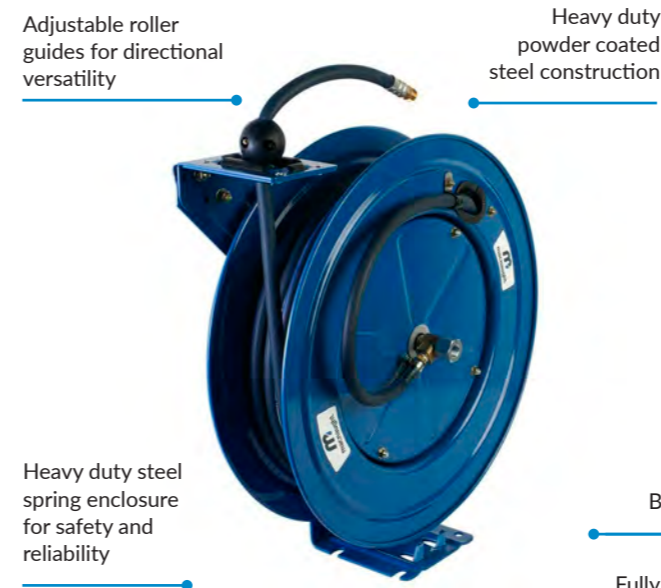

M RTP1320N-01, MR TP2520N-01



Part Number	MRS1320N-01	M RTP1320N-01	MR TP2520N-01
Description	Bare Single Pedestal Reel 12mm x 20m	Bare Twin Pedestal Reel 12mm x 20m	Bare Twin Pedestal Reel 25mm x 20m
Reel Type	Single Pedestal	Twin Pedestal	Twin Pedestal
Application	Air/Water/Oil	Air/Water/Oil	Air/Water/Oil
Hose Size (ID)	12mm (1/2")	12mm (1/2")	25mm (1")
Working Pressure	6900kPa (1000psi)	6900kPa (1000psi)	6900kPa (1000psi)
Reel Inlet	1/2" BSP(F)	1/2" BSP(F)	1" BSP(F)
Reel Outlet	1/2" BSP(F)	1/2" BSP(F)	1" BSP(F)
Hose Length Capacity	20m (65ft)	20m (65ft)	20m (65ft)

Applications:

All models are Ideal for use in all workshop applications. The range of twin pedestal reels are also suitable for off road service vehicle applications.

Recommended to be used with:



CCG-01 Coolant Control Nozzle



RETRACTA[®] 
by macnaught

RETRACTA IN THE INDUSTRY

Retracta is the benchmark in industrial strength retractable hose reels. Over the decades the original Retractable poly reel has built an enviable reputation worldwide for performance and reliability. Through this, and with a long history of innovation and design, Macnaught has now developed an exciting new range of Retractable reels specifically designed and engineered for the most demanding industrial applications and environments.

Innovation has always been at the centre of the Macnaught success story and it's the platform for developing our expanded Retractable range.

At Macnaught we call it "Innovation by Design".

Because we know that innovation is the only way to stay ahead. This is what sets us apart from our competitors and gives our customers confidence backed by up to 10 year* mechanical warranty and guaranteed parts availability.

* Note: Subject to Macnaught warranty terms and conditions see macnaught.com/warranty or see page 267.

Innovation by Design.

For 70 years, continual innovation has been the key to Macnaught's success. So, it's no surprise that through Macnaught's principle of "Innovation by Design" that a new and exciting range of Retracta reels has been developed.

For decades now the original Retracta poly reel has been developed and has built an enviable worldwide reputation for performance, reliability and safety. With this new suite of products, Retracta continues to set the benchmark for industrial strength, retractable hose reels.

This industry leading range now incorporates multiple reel constructions, specifically designed and engineered for the most demanding industrial applications and environments.



RetractaFLEX

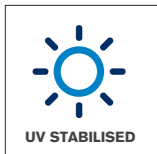

Adding to the stable of truly innovative products is the new range of RetractaFLEX hoses, available on a selection of our R3 Series reels. Featuring an innovative hybrid polymer that allows for the ultimate in flexibility and kink resistance under pressure.

The Retracta family has also expanded to include the sleek E-Series range of enclosed reels for automotive workshop gantries; the Hybrid H-Series steel framed twin pedestal reels which feature a robust ABS drum; and in another world first, the heavy duty F-Series powder coated steel pedestal and cradle frame reels, which include a unique series of integrated 'Metered' models.



10
YEARS
MACNAUGHT
WARRANTY

RACR®



The iconic Retracta poly reels have been re-imagined and updated; and in a world first, the new Retracta R3 range includes an adjustable control return system. The patented RACR® 'Retracta Adjustable Control Return' system is supplied on all R3-P+ models. The RACR® system offers true control by allowing the user to set the speed of return to suit their individual requirements.

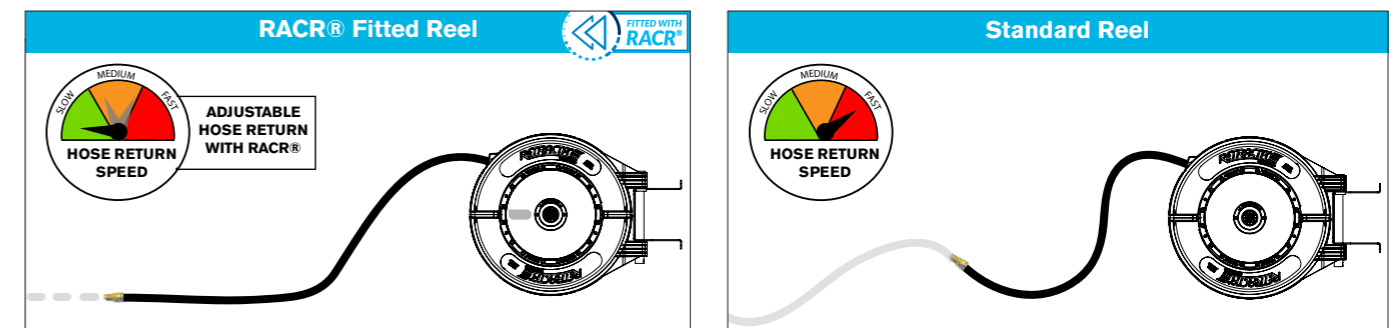

The RACR® reduces the hose speed up to 85% depending on user preference. The slower the hose speed, the safer the overall work environment - as the return speed avoids damages caused by the hose whip.

Look for the when choosing your reel.

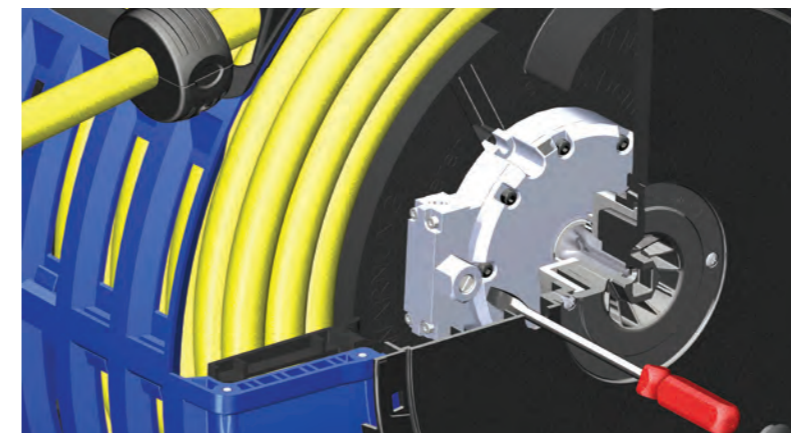

RACR benefits:

- Adjustable hose return speed
- Up to 85% speed reduction
- Eliminate hose whip hazard
- Essential safety for personnel and equipment

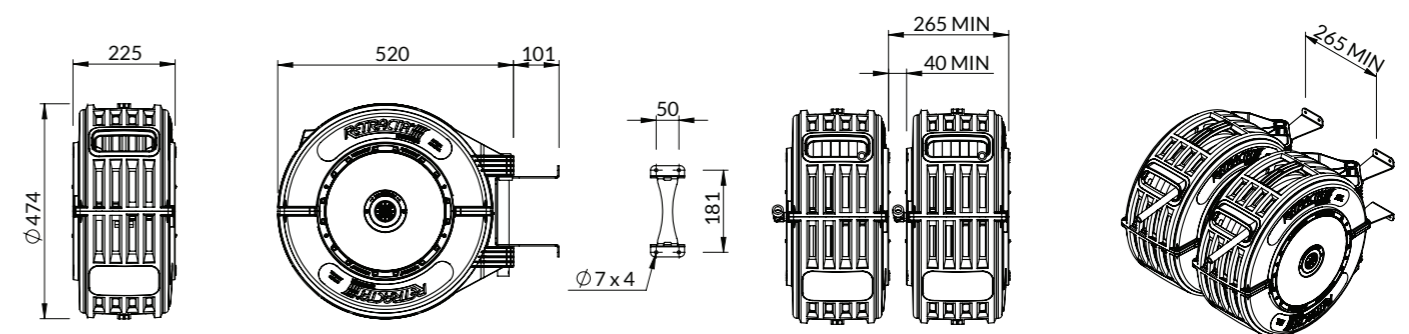

Retracta R3 RetractaFLEX Series

PREMIUM AIR & WATER HOSE REEL

Tangled hose lines will be a problem of the past. The NEW RetractaFLEX features an innovative hybrid polymer that allows for the ultimate in flexibility and kink resistance under pressure. Fitted with a bend restrictor at the hose end, the UV stabilised, abrasion-resistant outer layer provides maximum durability.



Great flexibility within temperature range

Kink-free under pressure

HI-VIS fluorescent colours for workplace safety

Memory free hose lays flat on the floor



Light weight and easy to handle

Unique patented RACR (on selected models)

Bend restrictor included*

Why choose this product?

The new RetractaFLEX hose reel comes standard with an innovative hybrid polymer hose allowing for ultimate flexibility and kink resistance under pressure.

Features & Benefits

- Innovative hybrid polymer hose – Ultimate flexibility
- High visibility Yellow, Orange colour hoses for visual identification & safety (Green for garden)
- Upgraded main spring made with TRC – Texture Rolled Carbon
- Safe tensioning mechanism
- High wear resistance mouth with ProGlide
- Fully serviceable
- RACR – on selected models

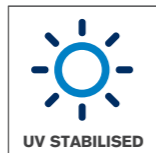

Applications:
Suitable for use across all industries

Service Parts available when requested.

AIR / WATER



Standard	RY315B-01	RY320B-01	RO320B-01	RY420B-01	RO420B-01	RY325B-01
RACR®	X	RYC320B-01	ROC320B-01	RYC420B-01	ROC420B-01	X
Case Colour	Blue	Blue	Blue	Blue	Blue	Blue
Hose Size (ID)	10mm (3/8")	10mm (3/8")	10mm (3/8")	12mm (1/2")	12mm (1/2")	10mm (3/8")
Hose Length	15m	20m	20m	20m	20m	25m
Hose Color	Yellow	Yellow	Orange	Yellow	Orange	Yellow
Hose Material	RetractaFLEX Hybrid Polymer					
Working Pressure	300 psi	300 psi	300 psi	300 psi	300 psi	300 psi
Max Temperature	60°C (140°F)	60°C (140°F)	60°C (140°F)	60°C (140°F)	60°C (140°F)	60°C (140°F)
Reel Inlet	3/8" BSP (F)	3/8" BSP (F)	3/8" BSP (F)	3/8" BSP (F)	3/8" BSP (F)	3/8" BSP (F)
Hose Outlet	1/4" BSP (M)	1/4" BSP (M)	1/4" BSP (M)	3/8" BSP (M)	3/8" BSP (M)	1/4" BSP (M)

NPT Models	RY365K-02	RY365R-02	RY465K-02	RY465R-02	RO365B-02	RO465B-02	RY382K-02
RACR®	RYC365K-02	RYC365R-02	RYC465K-02	RYC465R-02	ROC365B-02	ROC465B-02	X
Case Colour	Black	Red	Black	Red	Blue		Black
Hose Colour	Yellow				Orange		Yellow

Retracta R3 Series

COMPRESSED AIR - R3 PREMIUM

10
YEARS
MACNAUGHT
WARRANTY*

The Retracta R3 Premium series is the most robust and reliable hose & reel combination on the market. The highly durable Premium Reinforced PVC hose and industrial strength poly reel gives complete confidence in any demanding industrial compressed air application. The R3 Premium can be upgraded with the RACR system offering true control by allowing the user to set the speed of return to suit their individual requirements.

Unique patented RACR
(on selected models)

Working pressure
275psi

Flexible & abrasive
resistant hose cover

Available in
15m and 20m variants



Available in
3/8" (10mm) and
1/2"(12mm) hose sizes

Premium Reinforced
PVC hose

Fully Serviceable



Also available
in Blue cases

Why choose this product?

The robust Retracta R3 - AR series reels for compressed air all carry the Premium Reinforced PVC hose for maximum durability and high pressure rating.

Features & Benefits

- Highly durable Premium Reinforced PVC hose
- Upgraded main spring made with TRC – Texture Rolled Carbon
- Safe tensioning mechanism
- High wear resistance mouth with ProGlide
- Fully serviceable
- RACR® – on selected models

Applications:

Suitable for use across all industries

Service Parts available when requested.

COMPRESSED AIR

10
YEARS
MACNAUGHT
WARRANTY*

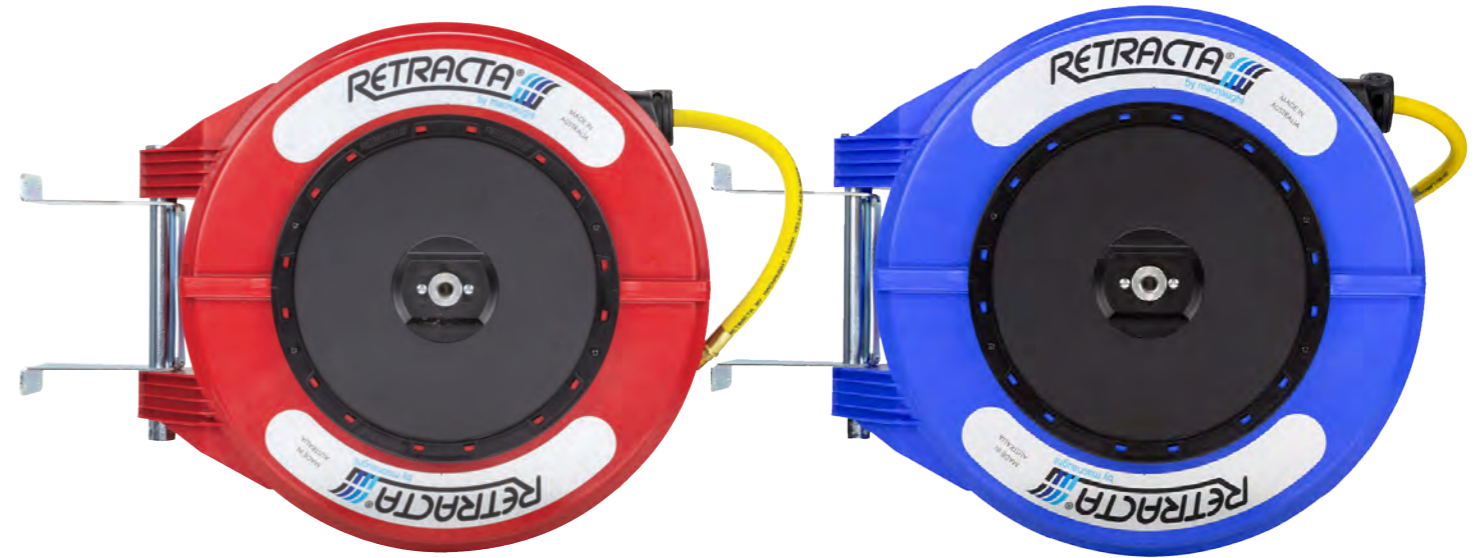

Standard	AR320R-01	AR415R-01	AR420R-01
RACR® 	ARC320R-01	ARC415R-01	ARC420R-01
Case Colour	Red	Red	Red
Hose Size (ID)	10mm (3/8")	12mm (1/2")	12mm (1/2")
Hose Length	20m	15m	20m
Hose Material	Premium Reinforced PVC	Premium Reinforced PVC	Premium Reinforced PVC
Working Pressure	275 psi	275 psi	275 psi
Max Temperature	60°C (140°F)	60°C (140°F)	60°C (140°F)
Reel Inlet	3/8" BSP (F)	3/8" BSP (F)	3/8" BSP (F)
Hose Outlet	1/4" BSP (M)	3/8" BSP (M)	3/8" BSP (M)
Other Options & Change Colour to Case	Standard	AR320B-01	AR420B-01
	RACR®	ARC320B-01	ARC420B-01
	Colour	Blue	Blue

Recommended to be used with:

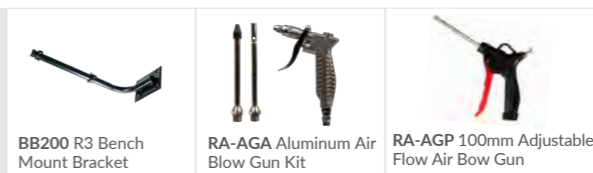

BB200 R3 Bench Mount Bracket

RA-AGA Aluminum Air Blow Gun Kit

RA-AGP 100mm Adjustable Flow Air Bow Gun

Retracta R3 Series

COMPRESSED AIR/WATER - R3 STANDARD



The Retracta R3 – Standard AW reel is the most common hose combination in workshops. With air and water compatibility, the AW is encased in the industrial strength poly reel and is ideal for most entry-level conditions.



COMPRESSED AIR/WATER



Why choose this product?

The robust Retracta R3 - AW series reels have the ability to carry both compressed air & water.

Features & Benefits

- Highly durable Premium Reinforced PVC hose
- Upgraded main spring made with TRC – Texture Rolled Carbon
- Safe tensioning mechanism
- High wear resistance mouth with ProGlide
- Fully serviceable

Applications:

Suitable for use across all industries

Service Parts available when requested.

Standard	AW315B-01	AW320B-01	AW415B-01	AW420B-01
Case Colour	Blue	Blue	Blue	Blue
Hose Size (ID)	10mm (3/8")	10mm (3/8")	12mm (1/2")	12mm (1/2")
Hose Length	15m	20m	15m	20m
Hose Material	Reinforced PVC	Reinforced PVC	Reinforced PVC	Reinforced PVC
Working Pressure	250 psi	250 psi	250 psi	250 psi
Max Temperature	60°C (140°F)	60°C (140°F)	60°C (140°F)	60°C (140°F)
Reel Inlet	3/8" BSP (F)	3/8" BSP (F)	3/8" BSP (F)	3/8" BSP (F)
Hose Outlet	1/4" BSP (M)	1/4" BSP (M)	3/8" BSP (M)	3/8" BSP (M)

Recommended to be used with:

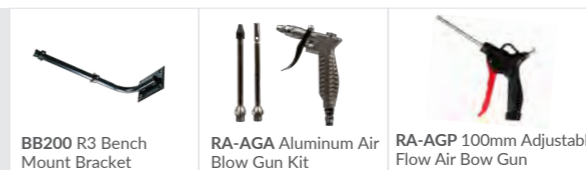

Retracta R3 Series

WATER - HOT WASH

10
YEARS
MACNAUGHT
WARRANTY*

The Retracta R3 – Hot Wash Reel is ideal for applications requiring high temperature water and pressure for cleaning or preparation.

Unique patented RACR
(on selected models)

Working pressure
290psi at 20°C
100psi at 80°C

Available in
15m and 20m variants



High Temperature
resistant PVC hose
rated to 85°C

1/2" (12mm) ID hose

Easy to clean hose cover

WATER - COLD WATER

10
YEARS
MACNAUGHT
WARRANTY*

The Retracta R3 - Cold Water reel is ideal for industrial applications requiring cold water delivery using a brass snap-on fitting.

Unique patented RACR
(on selected models)

Working pressure
150psi

Available in
15m and 20m variants



1/2" (12mm) ID hose

Flexible & abrasive
resistant hose cover

Premium Reinforced
PVC hose

Includes spray nozzle

Why choose this product?

The Retracta R3 Hot Wash reel is extremely reliable for hot water applications up to 85°C and 290psi. Ideal for use in food manufacturing and preparation, bars, clubs and service centres.

Standard	HW415R-01	HW420R-01
RACR® 	X	HWC420R-01
Case Colour	Red	Red
Hose Size (ID)	12mm (1/2")	12mm (1/2")
Hose Length	15m (50ft)	20m (65ft)
Hose Material	High Temp. Chemical Resistant PVC	
Working Pressure	290psi at 20°C 100psi at 80°C	
Max Temperature	85°C (185°F)	85°C (185°F)
Reel Inlet	1/2" BSP (F)	1/2" BSP (F)
Hose Outlet	1/2" BSP (M)	1/2" BSP (M)
NPT Model	HW465R-02	X

Features & Benefits

- Hose applicable for use with hot water up to temperatures of 85°C
- High temp resistant PVC with pressure rating to 290psi at 20°C
- Fully serviceable
- RACR® - on selected models

Applications:

Cleaning food processing area and equipment in meat, poultry, confectionery and dairy. Hot water wash down areas including bars, clubs, commercial kitchen and service centre

Service Parts available when requested.

Why choose this product?

The Retracta R3 Cold Water reel is suited for industrial applications requiring high pressure water delivery via brass snap-on fitting.

Standard	CW420B-01
RACR® 	CWC420B-01
Case Colour	Blue
Hose Size (ID)	12mm (1/2")
Hose Length	20m (65ft)
Hose Material	Premium reinforced PVC
Working Pressure	150psi
Max Temp.	60°C (140°F)
Reel Inlet	1/2" BSP (F)
Hose Outlet	Brass hose connector

Features & Benefits

- Premium reinforced PVC hose pressure rated to 150psi
- Brass hose connector
- Fully serviceable
- RACR® - on selected models

Applications:

Food and industrial wash down application. Outdoor, Garden and Horticultural

Service Parts available when requested.

Recommended to be used with:



BB200 R3 Bench Mount Bracket

Recommended to be used with:



BB200 R3 Bench Mount Bracket

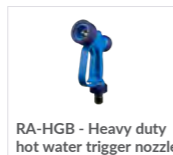

RA-HGB - Heavy duty hot water trigger nozzle



RA-HGP - Hot water trigger nozzle

Retracta R3 Series

WATER - HIGH PRESSURE

The Retracta R3 – High Pressure reel is coupled with a steel wire braided rubber hose and industrial strength hose reel case ensuring complete confidence in high pressure water delivery.



Unique patented RACR (on selected models)

Working pressure 3,000psi

Premium Wire Reinforced Rubber Hose



3/8" (10mm) ID hose

Abrasive resistant hose cover

Fully Serviceable

Why choose this product?

The Retracta R3 High Pressure reel is the ultimate in high pressure water delivery. Rated to pressures up to 3000psi and temperatures up to 95°C this reel and hose combination also delivers confidence in most water applications.

Features & Benefits

- Hose applicable for high pressure applications up to 3,000psi
- Rated to water temperatures up to 95°C
- Fully serviceable
- RACR® – on selected models

Applications:

Outdoor high pressure cleaning, industrial cleaning, car wash

Service Parts available when requested.

Recommended to be used with:



BB200 R3 Bench Mount Bracket

WATER - GARDEN/HORTICULTURE

The Retracta R3 – Garden/Horticulture reel is available in 2 different reel case colours and come standard with the innovative RetractaFLEX hybrid polymer hose.



Unique patented RACR (on selected models)

Working pressure 150psi

RetractaFLEX Hybrid Polymer

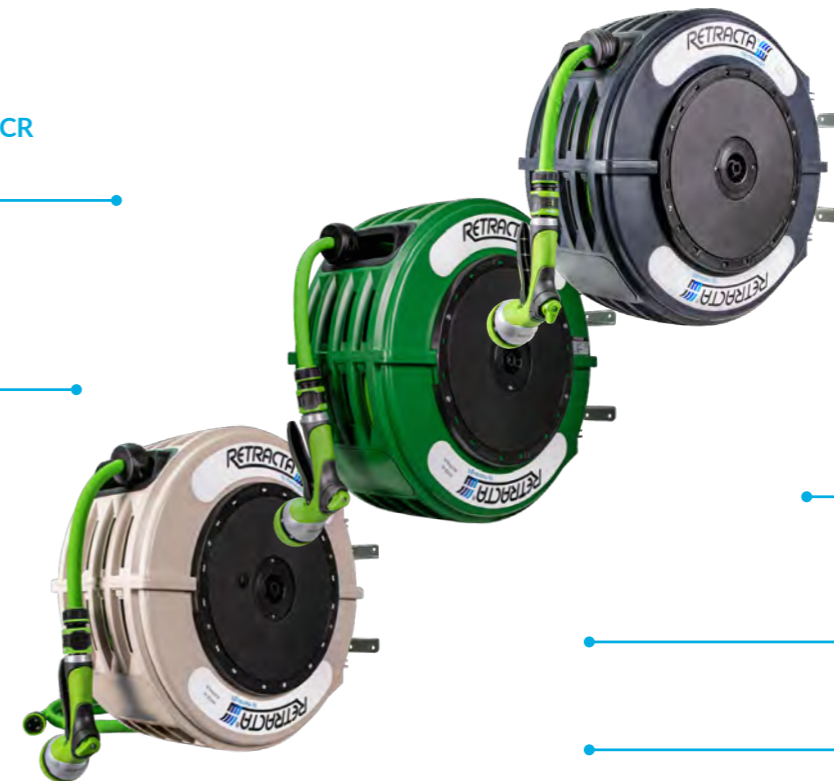

1/2" (12mm) ID hose

Kink-free under pressure

Superior flexibility

Includes 2m feeder hose and Multi-pattern spray gun

Available in 18m and 25m

Why choose this product?

The Retracta R3 Garden/Horticulture looks as good as it works in garden and horticultural applications. Available in 2 different colours, the innovative RetractaFLEX hose comes standard.

Features & Benefits

- Hybrid polymer hose to prevent hose tangles and kinking.
- High wear resistance mouth with ProGlide
- Fully serviceable
- RACR® – on selected models

Standard	DR418G-03	DR425G-03	DR418P-03	DR425P-03	DR418D-03	DR425D-03
RACR®	DRC418G-03	DRC425G-03	DRC418P-03	DRC425P-03	X	X
Case Colour	Green		Beige		Dark Grey	
Hose Size (ID)	12mm (1/2")					
Hose Length	18m	25m	18m	25m	18m	25m
Hose Color	Green					
Hose Material	RetractaFLEX Hybrid Polymer					
Working Pressure	150 psi					
Max Temperature	60°C (140°F) Hose & Tap Connector					
Reel Inlet	Hose Connector					
Hose Outlet	Hose Connector					
NPT Model	DR460G-05	DR482G-05	DR460P-05	DR482P-05	DR460D-05	DR482D-05

Applications:

Domestic outdoor, garden and horticultural.

Service Parts available when requested.

Recommended to be used with:



BB200 R3 Bench Mount Bracket

Retracta R3 Series

OIL

The Retracta R3 Oil reels are supplied with two different lengths of hoses supported by a dark grey or blue reel. The R3 Premium can be upgraded with the RACR system offering true control by allowing the user to set the speed of return to suit their individual requirements.



Unique patented RACR (on selected models)

Working pressure 1,000psi

Premium SAE Wire Reinforced Rubber Hose

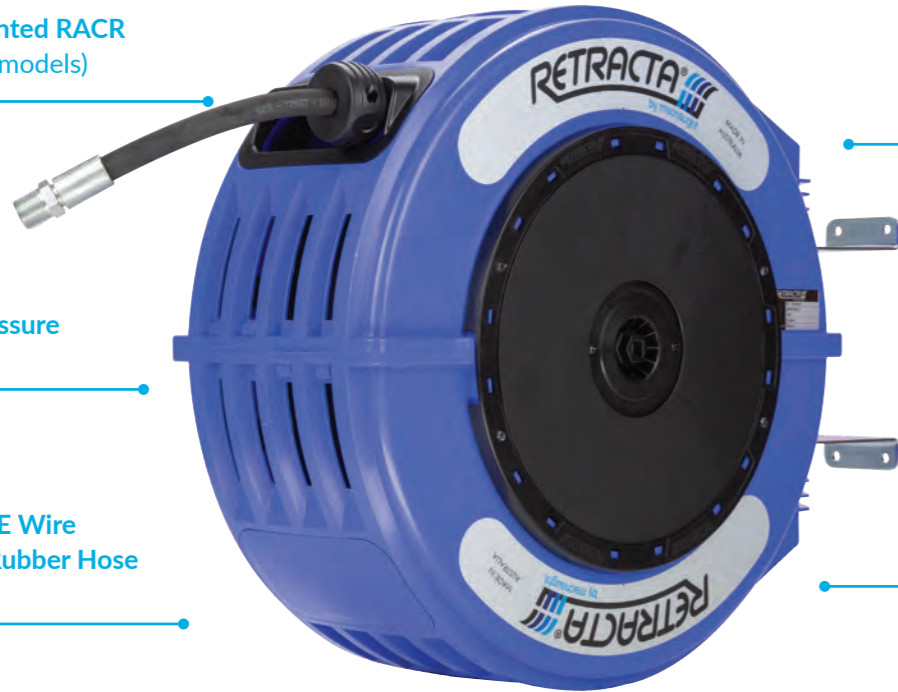

Available in 1/2" (12mm) hose sizes

Abrasive resistant smooth hose cover

Fully Serviceable

Standard	OMP415B-01
RACR®	OMPC415B-01
Case Colour	Blue
Hose Size (ID)	12mm (1/2")
Hose Length	15m
Hose Material	Wire Reinforced Rubber (SAE100R17)
Working Pressure	1000 psi
Max Temperature	90°C (194°F)
Reel Inlet	1/2" BSP (F)
Hose Outlet	1/2" BSP (M)
NPT Models	OMP450K-02
RACR®	OMPC450K-02

Features & Benefits

- Highly durable Double Reinforced Rubber (R3 Premium) or Steel Wire Braided Rubber
- Upgraded main spring made with TRC - Texture Rolled Carbon
- Safe tensioning mechanism
- High wear resistance mouth with ProGlide
- Fully serviceable
- RACR® - on selected models

Why choose this product?

The R3 oil reels are ideal choice for peace of mind reliability and performance.

Applications:
Suitable for use across all industries

Service Parts available when requested.

Recommended to be used with:



GREASE

The Retracta R3 Grease reels are supplied with 2 different lengths of hoses supported by a black or blue reel. The R3 Premium can be upgraded with the RACR system offering true control by allowing the user to set the speed of return to suit their individual requirements.



Unique patented RACR (on selected models)

Working pressure 5,000psi

Premium SAE Wire Reinforced Rubber Hose

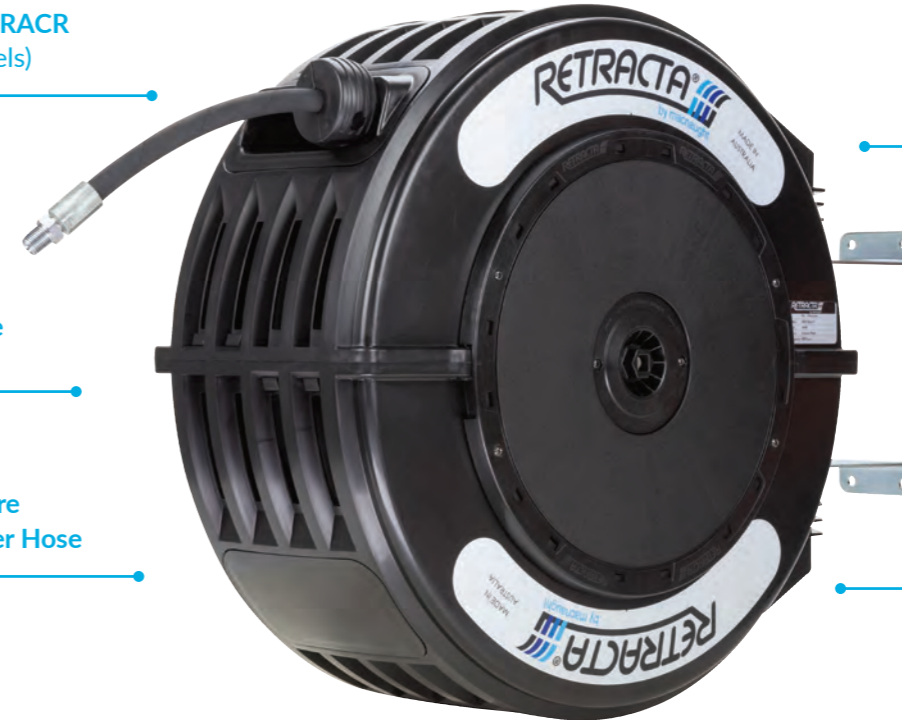

Available in 1/4" (6mm) hose sizes

Abrasive resistant hose cover

Fully Serviceable

Standard	GR215K-01	GR210B-01
Case Colour	Black	Blue
Hose Size (ID)	6mm (1/4")	6mm (1/4")
Hose Length	15m	10m
Hose Material	Wire Reinforced Rubber (SAE100R2)	Wire Reinforced Rubber (SAE100R2)
Working Pressure	5000 psi	5000 psi
Max Temperature	100°C (212°F)	100°C (212°F)
Reel Inlet	1/4" BSP (F)	1/4" BSP (F)
Hose Outlet	1/4" BSP (M)	1/4" BSP (M)
NPT Models	GR250K-02	X

Why choose this product?

The R3 grease reels are ideal choice for peace of mind reliability and performance.

Applications:
Suitable for use across all industries

Features & Benefits

- Highly durable Double Reinforced Rubber (R3 Premium) or Steel Wire Braided Rubber
- Upgraded main spring made with TRC - Texture Rolled Carbon
- Safe tensioning mechanism
- High wear resistance mouth with ProGlide
- Fully serviceable
- RACR® - on selected models

Service Parts available when requested.

Recommended to be used with:



Retracta R3 Series

WELDING GAS - OXY/ACET

The Retracta R3 Oxy/Acetylene reel is supplied with twin gas hose, made from reinforced rubber compliant to AS 1335 to ensure outstanding support in the welding environment. RACR version also available.



WELDING GAS - OXY/LPG

The Retracta R3 Oxy/LPG reel is supplied with twin gas hose, made from reinforced rubber compliant to AS 1335 to ensure outstanding support in the welding environment. RACR version also available.



Why choose this product?

Built for peace of mind reliability, performance and safety

Standard	OA215B-04
RACR®	OAC215B-04
Case Colour	Blue
Hose Size (ID)	Twin 5mm (3/16")
Hose Length	15m
Hose Material	Reinforced Rubber (AS1335)
Working Pressure	175 psi
Max Temperature	80°C (176°F)
Reel Inlet	Gas Thread UNF (M)
Hose Outlet	Gas Thread UNF (F)

Features & Benefits

- Highly durable Double Reinforced Rubber
- Upgraded main spring made with TRC – Texture Rolled Carbon
- Safe tensioning mechanism
- High wear resistance mouth with ProGlide
- Fully serviceable
- RACR® – on selected models

Applications:

Suitable for use in all industries where Oxy /Acetylene is required

Service Parts available when requested.

Recommended to be used with:



BB200 R3 Bench Mount Bracket

Why choose this product?

Built for peace of mind reliability, performance and safety

Standard	OG215K-04
RACR®	OGC215K-04
Case Colour	Black
Hose Size (ID)	Twin 5mm (3/16")
Hose Length	15m
Hose Material	Reinforced Rubber (AS1335)
Working Pressure	175 psi
Max Temp.	60°C (140°F)
Reel Inlet	Gas Thread UNF (M)
Hose Outlet	Gas Thread UNF (F)

Features & Benefits

- Highly durable Double Reinforced Rubber
- Upgraded main spring made with TRC – Texture Rolled Carbon
- Safe tensioning mechanism
- High wear resistance mouth with ProGlide
- Fully serviceable
- RACR® – on selected models

Applications:

Suitable for use in all industries where Oxy /LPG is required

Service Parts available when requested.

Recommended to be used with:



BB200 R3 Bench Mount Bracket

Retracta R3 Series

WELDING GAS - ARGON

The Retracta R3 Argon reel is supplied with a 20 metre hose, made from reinforced rubber compliant to AS 1335 to ensure outstanding support in the welding environment specifically to handle Argon. RACR version also available.

10
YEARS
MACNAUGHT
WARRANTY

Unique patented RACR
(on selected models)

Working pressure
Up to 200psi

UNF Gas Thread

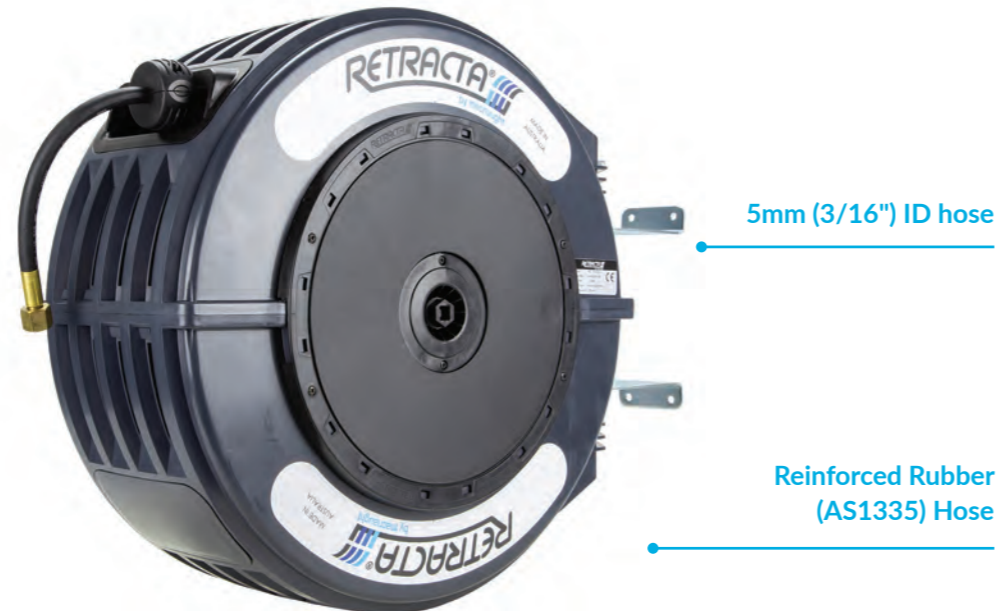

WELDING GAS - LPG

The Retracta R3 LPG reel is supplied with a 20 metre hose, made from reinforced rubber compliant to AS 1335 to ensure outstanding support in the welding environment specifically to handle LPG. RACR version also available.

10
YEARS
MACNAUGHT
WARRANTY

Unique patented RACR
(on selected models)

Working pressure
Up to 200psi

UNF Gas Thread

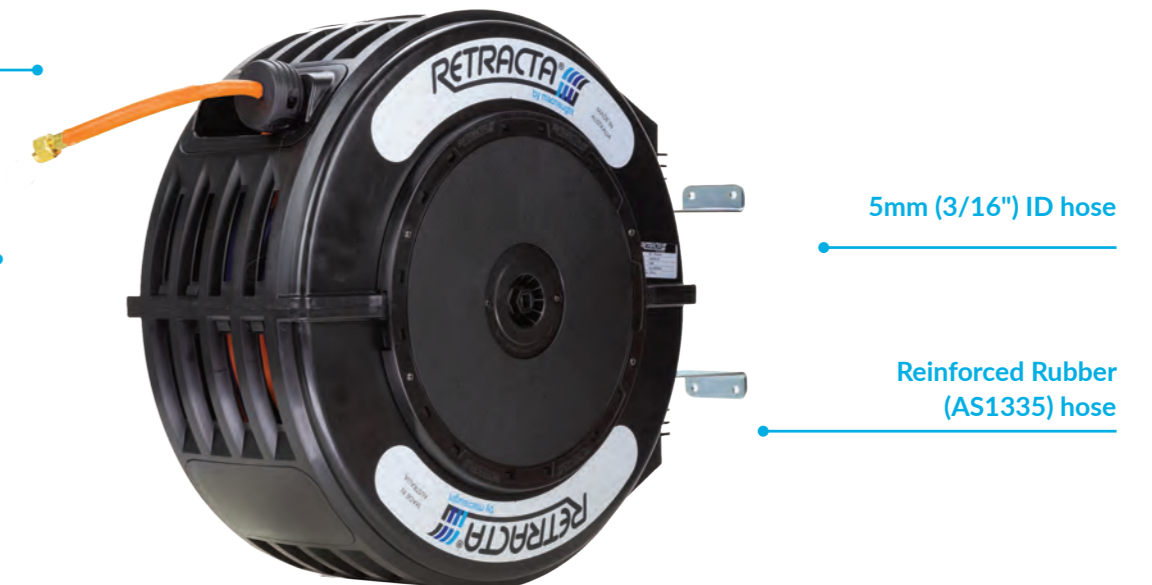

Why choose this product?

The R3 Argon gas reel can be used in all applications for arc welding such as gas metal arc welding and gas tungsten arc welding.

Standard	ARG220D-04
Case Colour	Dark Grey
Hose Size (ID)	5mm (3/16")
Hose Length	20m
Hose Material	Reinforced Rubber (AS1335)
Working Pressure	200 psi
Max Temperature	60°C
Reel Inlet	Gas Thread UNF (M)
Hose Outlet	Gas Thread UNF (F)

Features & Benefits

- Highly durable Double Reinforced Rubber
- Upgraded main spring made with TRC – Texture Rolled Carbon
- Safe tensioning mechanism
- High wear resistance mouth with ProGlide
- Fully serviceable

Applications:

Service Bays / Garages, Manufacturing / Fabrication Shops, Construction, Welding Carts, Shipyards, Transport Service.

Service Parts available when requested.

Recommended to be used with:



BB200 R3 Bench Mount Bracket

Why choose this product?

The R3 LPG hose reel has been created for the delivery and transfer of propane gas in commercial & industrial applications encased in a Retracta R3 reel.

Standard	LPG220K-04
Case Colour	Black
Hose Size (ID)	5mm (3/16")
Hose Length	20m
Hose Material	Reinforced Rubber (AS1335)
Working Pressure	200 psi
Max Temperature	60°C
Reel Inlet	Gas Thread UNF (M)
Hose Outlet	Gas Thread UNF (F)

Features & Benefits

- Highly durable Double Reinforced Rubber
- Upgraded main spring made with TRC – Texture Rolled Carbon
- Safe tensioning mechanism
- High wear resistance mouth with ProGlide
- Fully serviceable

Applications:

Service Bays / Garages, Manufacturing / Fabrication Shops, Construction, Welding Carts, Shipyards, Transport Service.

Service Parts available when requested.

Recommended to be used with:



BB200 R3 Bench Mount Bracket

Retracta R3 Series

CHEMICAL - WEEDICIDE / PESTICIDE

The Retracta R3 Weedicide/Pesticide reel is supplied with a 16 metre chemical resistant PVC hose designed specifically to handle, transfer and dispense weedicide, pesticide and chemical. RACR version also available.



Unique patented RACR (on selected models)

Working Pressure: 250 psi

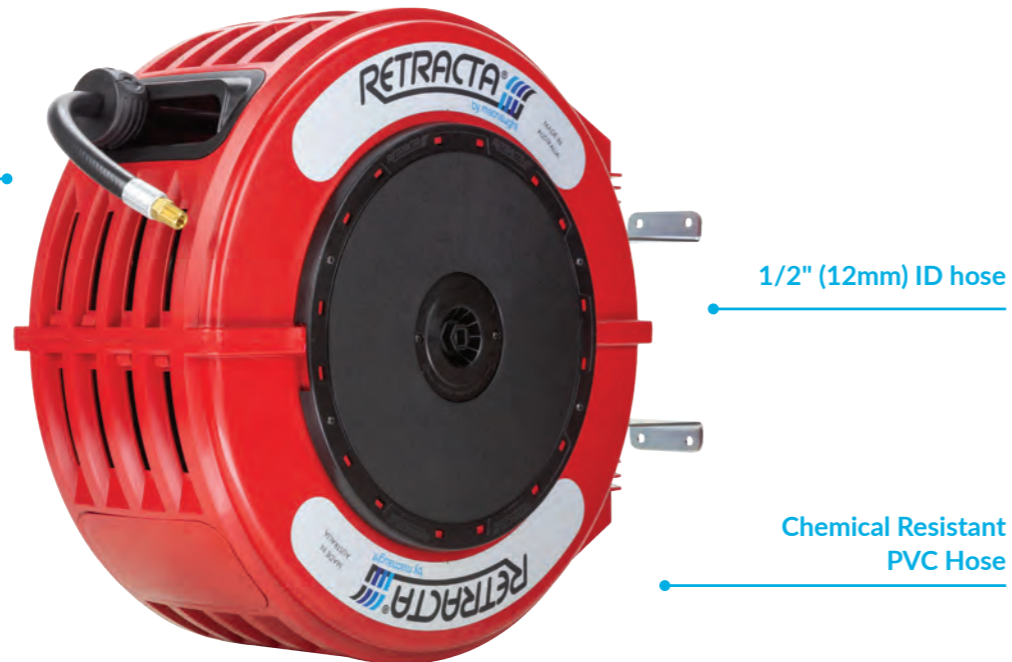

Why choose this product?

The R3 Weedicide/Pesticide hose reel has been created for the delivery and transfer of weedicide, pesticide and general chemicals.

Standard	WD316R-01
RACR®	WDC316R-01
Case Colour	Red
Hose Size (ID)	10mm (3/8")
Hose Length	16m
Hose Material	Chemical Resistant PVC
Working Pressure	250 psi
Max Temperature	60°C (140°F)
Reel Inlet	3/8" BSP (F)
Hose Outlet	1/4" BSP (M)

Features & Benefits

- Highly durable Chemical resistant PVC
- Upgraded main spring made with TRC - Texture Rolled Carbon
- Safe tensioning mechanism
- High wear resistance mouth with ProGlide
- Fully serviceable
- RACR® - on selected models

Applications:

Farming, Horticulture, Chemical plant and Outdoor

Recommended to be used with:



BB200 R3 Bench Mount Bracket

Retracta R3 Series

F.R.A.S. AIR / WATER REEL

The Retracta R3 FRAS reel is supplied with a 15 metre reinforced PVC hose, featuring fire resistant anti-static property to meet the mining specific application. Reel constructed in polypropylene and brass, no aluminium.



Equipped with Fire Resistant Anti Static Hose

Working Pressure: 300 psi

Abrasive resistant hose cover

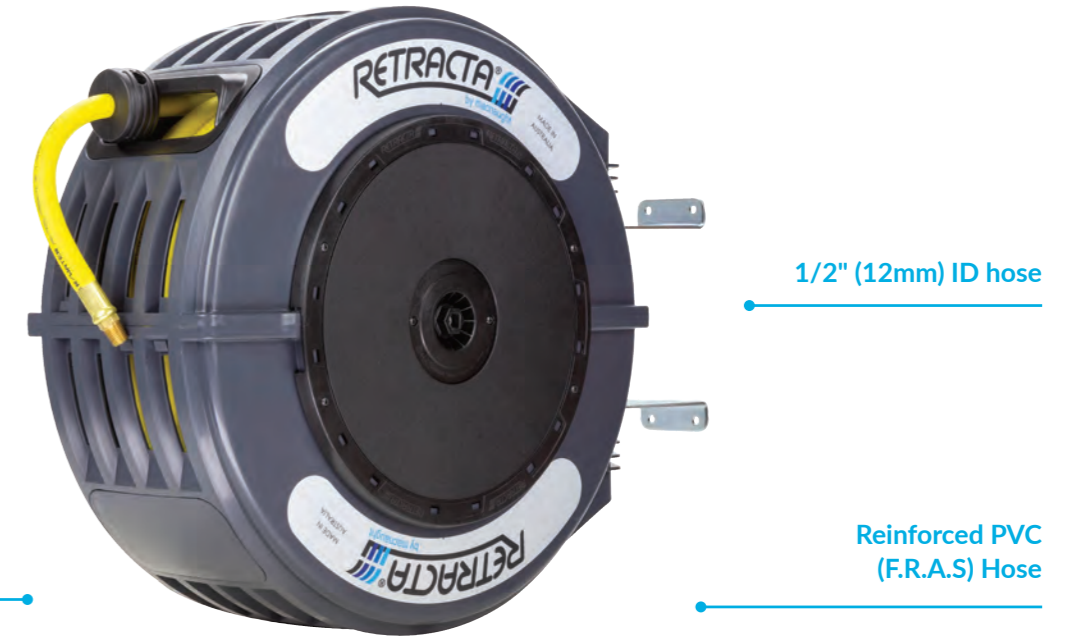

*Fire Resistant Anti Static only applicable to hose, not including reel body

Why choose this product?

The Retracta FRAS reel features hose made with fire resistant material and a conductive outer strip connected to its conductive inner wall. Combine with our durable Retracta R3, it ideal for harsh mining environment.

Standard	FRAS415D-01
Case Colour	Dark Grey
Hose Size (ID)	12mm (1/2")
Hose Length	15m
Hose Material	Reinforced PVC (F.R.A.S)
Working Pressure	300 psi
Max Temperature	60°C (140°F)
Reel Inlet	1/2" BSP (F)
Hose Outlet	1/2" BSP (M)

Features & Benefits

- Highly durable reinforced PVC (F.R.A.S)
- Upgraded main spring made with TRC - Texture Rolled Carbon
- Safe tensioning mechanism
- High wear resistance mouth with ProGlide
- Fully serviceable
- RACR® - on selected models

Applications:

Food processing and food preparation. Hot water wash down areas including bars, clubs and service centres.

Recommended to be used with:



BB200 R3 Bench Mount Bracket

ACCESSORIES

The Retractable range has now expanded to include sleek new accessories specially designed for our iconic Retractable poly Hose Reels. From new Air Blow Guns, to new fittings and nozzles, all Retractable accessories have been made to compliment our hose reels.



Aluminum Air Blow Gun Kit
RA-AGA

Features & Benefits

- Light weight and durable aluminium body
- 3/4" Nitto style fitting included
- 3 Nozzles included for versatile application
- Compact ergonomic handle design



100mm Adjustable Flow Air Blow Gun
RA-AGP

Features & Benefits

- 3/4" Nitto style fitting included
- Adjustable flow control
- Ergonomic handle design
- Steel insert thread connection
- Durable nylon body for impact and wear resistant



R3 Multi Position Locking Bracket
RA-MLB

Features & Benefits

- Hold and lock hose reel at desired angle and direction
- Simple setup and easy to adjust
- Compatible to existing Retractable R3 hose reels



Heavy Duty Hot Water Trigger Nozzle
RA-HGB

Features & Benefits

- Adjustable spray pattern by trigger (conical/pencil)
- Swivel inlet
- Ergonomic design
- Lightweight plastic construction
- Heavy duty Shock proof rubber ring



Hot Water Trigger Nozzle
RA-HGP

Features & Benefits

- Adjustable spray pattern by trigger (conical/pencil)
- Swivel inlet
- Ergonomic design
- Lightweight construction with trigger guard
- Shock proof protective rubber ring



Brass Water Spray Nozzle
RA-CNB

Features & Benefits

- Spray adjusts from mist to powerful jet
- Robust brass construction with a soft rubber grip



Coolant / Water Bib Dispenser Valve
RA-CBM

Features & Benefits

- Curved rubber tip for ease of dispensing
- Coolant / Water bib
- Coolant / Water faucet
- Radiator bib

Part Number	Description
AIR BLOW GUN	
RA-AGA	Aluminium Air Blow Gun Kit
RA-AGP	100mm Adjustable Flow Air Blow Gun
WATER NOZZLES	
RA-CNB	Brass Water Spray Nozzlev
RA-HGB	Heavy Duty Hot Watter Trigger Nozzle
RA-HGP	Hot Watter Trigger Nozzle
RA-CBM	Coolant / Water Bib Dispenser Valve
LOCKING BRACKET	
RA-MLB	R3 Multi Position Locking Bracket

RETRACTAFLEX AIR HOSE



For a light weight and easy to handle air hose, try out our RetractableFLEX Air Hose. This hybrid polymer high flex hose is kink-free under pressure and features a HI-VIS orange colour for workplace safety.



Part Number	Description
RETRACTAFLEX AIR HOSE	
AH1010	3/8" x 10m with Nitto Style Coupler
AH1020	3/8" x 20m with Nitto Style Coupler
AH1030	3/8" x 30m with Nitto Style Coupler
AH1210	1/2" x 10m with Nitto Style Coupler
AH1220	1/2" x 20m with Nitto Style Coupler
AH1230	1/2" x 30m with Nitto Style Coupler

RetractableFLEX AIR HOSE

Features & Benefits

- Hybrid polymer high flex hose
- Kink-free under pressure
- Memory free hose, lays flat on the floor
- Light weight and easy to handle
- Nitto style 1 touch quick release fittings



Part Number	Description
NITTO STYLE AIR FITTING	
RA-20PM	1/4" Nitto Style Plug 1/4" Bsp Male Air Fitting
RA-20PF	1/4" Nitto Style Plug 1/4" Bsp Female Air Fitting
RA-20SM	1/4" Nitto Style Socket 1/4" Bsp Male Air Fitting
RA-20SF	1/4" Bsp Female Fitting to Nitto Socket
RA-30SF	3/8" Bsp Female Fitting to Nitto Socket
RA-30SH30PH	Nitto Style Air Fitting Set for 3/8" Hose
RA-40SH40PH	Nitto Style Air Fitting Set for 1/2" Hose

Nitto Style Air Fitting

Features & Benefits

- Compatible with genuine Nitto couplings air tool fitting
- Corrosion resistant with Chrome plated steel
- Maximum working pressure up to 215 psi (15 bar)

Retracta F Series HD Twin Pedestal

F-SERIES PEDESTAL

Built with demanding Australian conditions in mind, the heavy duty powder coated steel F-Series Twin Pedestal hose reel boasts sealed bearings, stainless steel shafts, solid three sector ratchets, Viton® O'rings, quality hoses and corrosion resistant fixings. A narrow face dimension has been maintained to allow multiple reels to be fitted in tight locations such as the mine site service vehicle. Industry common footprints allow for minimum changes to cabinet design. Common threads are used at inlet, outlet and hose fittings and spare parts are available.



High quality hose and fittings
Industrial grade, model specific hydraulic hose suitable for most common applications

Viton® O'rings

Fully Repairable
Replacement parts are available

Stainless Steel Shaft for multi fluid use
For multiple applications from oils and grease to water and coolants. Grease specific 3/8" high pressure model has zinc coated MS shaft.

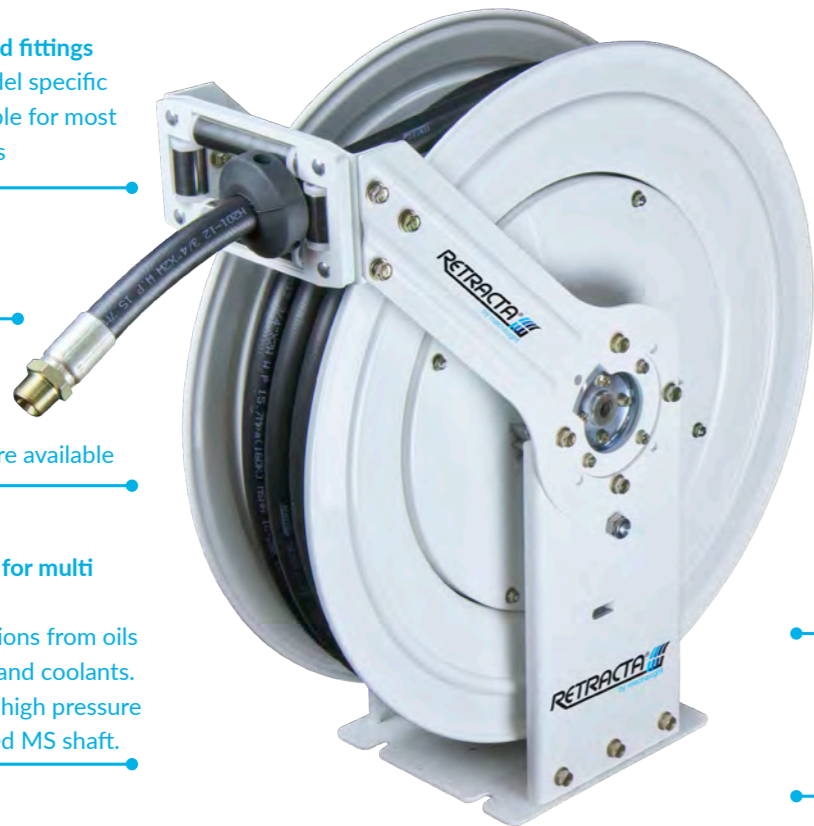

High strength powder coated steel construction
For durability and use in arduous mobile conditions.

Adjustable roller guide arm
Allows multiple position mounting

Sealed Bearings
For longer life against dust and water ingress

1m connection hose included

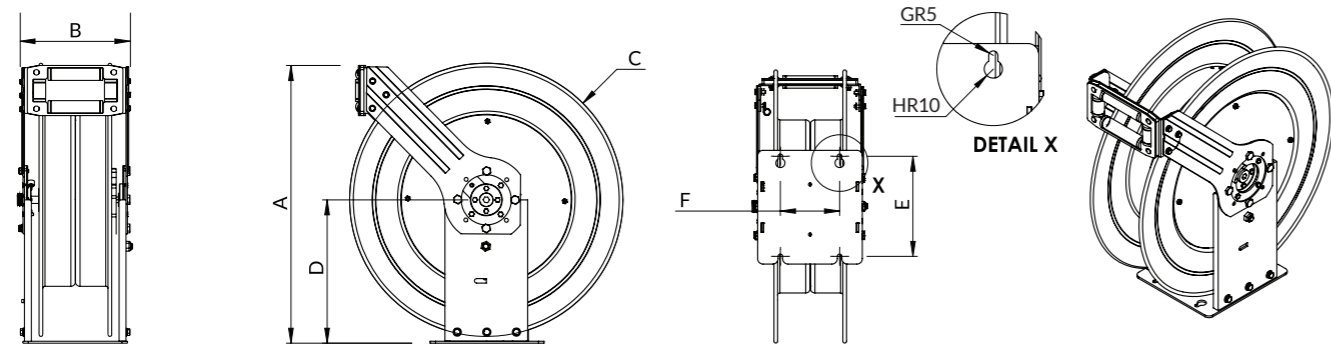

- 3/4" Twin Pedestal Reel Illustrated - Dimensions are in mm

Reel Dimension	A	B	C	D	E	F	G	H	Min Bend Radius
Reel 1	550	180	Ø515	280	216	130	R4.8	R10	140
Reel 2	600	248	Ø575	315	220	130	R5	R10	190

F-SERIES HEAVY DUTY TWIN PEDESTAL

Part Number	FHG0915-01	FHA1220-01	FHO1215-01	FHO1915-01
Application	Grease	Air/Water	Oil/Diesel	Oil/Diesel
Hose Size (ID)	10mm (3/8")	12mm (1/2")	12mm (1/2")	19mm (3/4")
Hose Length	15m	20m	15m	15m
Hose Material	3 Wire Rforced Rubber	Reinforced PVC	Wire Reinforced Rubber (SAE 100R1)	Wire Reinforced Rubber (SAE 100R2)
Working Pressure	5000 psi	250 psi	2000 psi	1450 psi
Max Temperature	100° C	60° C	100° C	100° C
Reel Inlet	3/8" BSP (F)	1/2" BSP (F)	1/2" BSP (F)	3/4" BSP (M)
Hose Outlet	3/8" BSP (M)	1/2" BSP (M)	1/2" BSP (M)	3/4" BSP (M)
Reel Dimension	Reel 1	Reel 2	Reel 1	Reel 2

Part Number	FHM1200-01	FHM1900-01
Application	Air/Water/Oil	Air/Water/Oil
Hose Size (ID)	12mm (1/2")	19mm (3/4")
Hose Capacity	15m capacity	15m capacity
Hose Material	Bare Reel - hose excluded	
Working Pressure	2000 psi	1450 psi
Max Temperature	100° C	100° C
Reel Inlet	1/2" BSP (F)	3/4" BSP (F)
Swivel Outlet	1/2" BSP (F)	3/4" BSP (F)
Reel Dimension	Reel 1	Reel 2

Applications:
Suitable for all industries including underground mining applications

Recommended to be used with:



Retracta *F Series* HD Cradle

F-SERIES CRADLE

Built with demanding Australian conditions in mind, the heavy duty powder coated steel F-Series Cradle hose reel boasts sealed bearings, stainless steel shafts, solid three sector ratchets, Viton O'rings, quality hoses and corrosion resistant fixings. A narrow face dimension has been maintained to allow multiple reels to be fitted in tight locations such as the mine site service vehicle. Industry common footprints allow for minimum changes to cabinet design. Common threads are used at inlet, outlet and hose fittings and spare parts are available.



High quality hose and fittings
Industrial grade, model specific hydraulic hose suitable for most common applications

Fully Repairable
Replacement parts are available

Stainless Steel Shaft
for multi fluid use
For multiple applications from oils and grease to water and coolants.

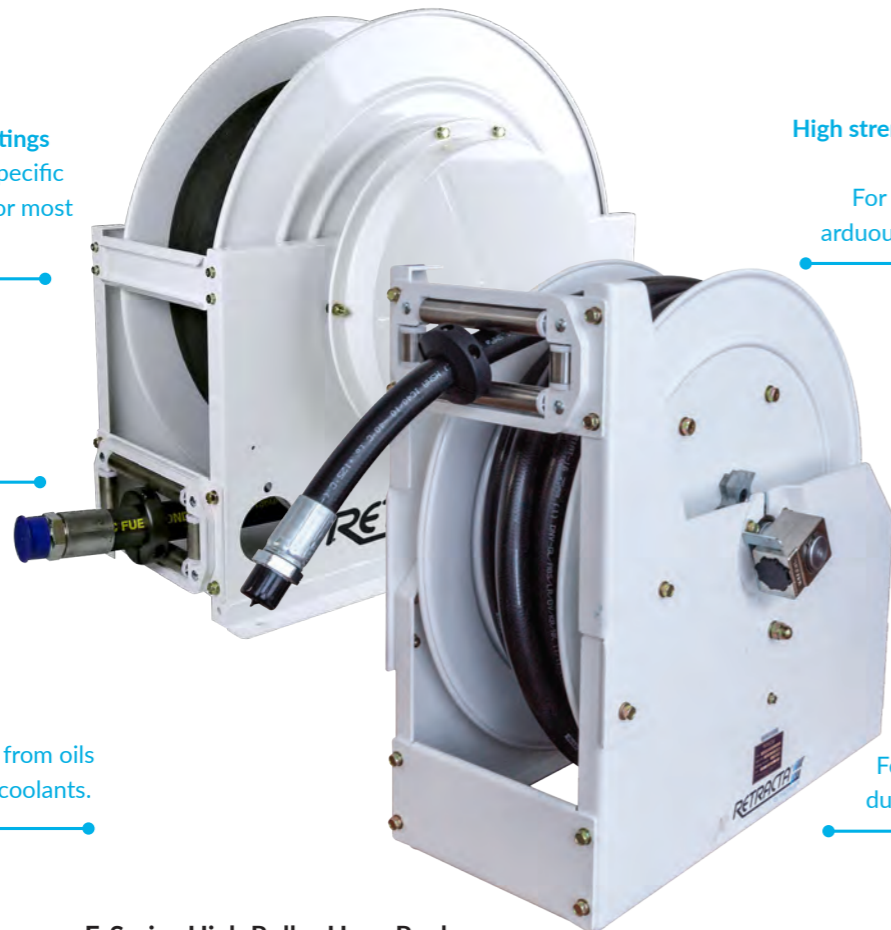

High strength powder coated steel construction
For durability and use in arduous mobile conditions.

Sealed Bearings
For longer life against dust and water ingress

F-Series High Roller Hose Reel (F-Series High Roller Model)

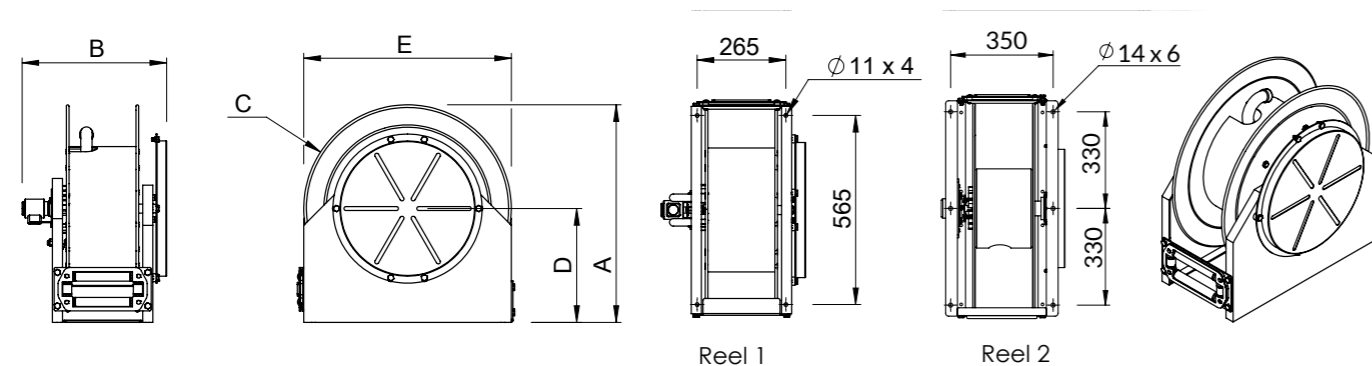

- Dimensions are in mm

Reel Dimension	A	B	C	D	E	Min Bend Radius
Reel 1	650	404	Ø620	340	620	180
Reel 2	728	425	Ø715	370	735	130

F-SERIES HEAVY DUTY CRADLE

Part Number	FCW1920-01	FCW2515-01	FCD2515-01	FCD3815-02
High Roller Part Number	FRW1920-01	FRW2515-01	FRD2515-01	FRD3815-02
Application	Air/Water	Air/Water	Oil/Diesel	Oil/Diesel
Hose Size (ID)	19mm (3/4")	25mm (1")	25mm (1")	38mm (1 - 1/2")
Hose Length	20m	15m	15m	15m
Hose Material	Reinforced PVC		Wire Reinforced Rubber (SAE 100R1)	
Working Pressure	250 psi	250 psi	1000 psi	500 psi
Max Temperature	60° C	60° C	100° C	100° C
Reel Inlet	3/4" BSP (F)	1" BSP (F)	1" BSP (F)	1 - 1/2" NPT (F)
Hose Outlet	3/4" BSP (M)	1" BSP(M)	1" BSP(M)	1 - 1/2" NPT (M)
Reel Dimension	Reel 1	Reel 1	Reel 1	Reel 2

Part Number	FCM2500-01	FCM3800-02
High Roller Part Number	FRM2500-01	FRM3800-02
Application	Air/Water/Oil/Diesel	Air/Water/Oil/Diesel
Hose Size (ID)	25mm (1")	38mm (1 - 1/2")
Hose Capacity	15m capacity	15m capacity
Hose Material	Bare Reel - hose excluded	
Working Pressure	1450 psi	500 psi
Max Temperature	100° C	100° C
Reel Inlet	1" BSP(F)	1 - 1/2" NPT (F)
Swivel Outlet	1" BSP(F)	1 - 1/2" NPT (F)
Reel Dimension	Reel 1	Reel 2

Applications:
Suitable for all industries including underground mining applications

Recommended to be used with:

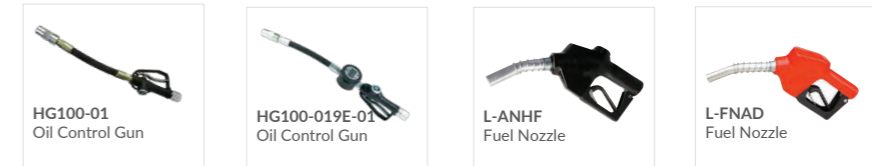

Retracta F Series Metered HD Twin Pedestal

Retracta F Series Metered HD Cradle by macnaught

F-SERIES METERED

The F-Series Metered hose reel represents the first hose reel developed worldwide with integrated flow meter and flow register. Offering unparalleled simplicity for OEMs, installers and users alike, there is no longer any need for separate mounting of meters, intermediate plumbing or vulnerable wiring between meters and registers. The reel comes completely fitted and wired to be placed in situ ready to function. The only installation required is bolting the unit down and the connection of the inlet fluids and outlet control. Although equally at home in static workshop situations, the F-Series range of metered hose reels has been specifically designed to meet the rigors of the mobile lube service vehicle.



Integrated Meter

Meter unit is protected by integration behind reel frame

Durable heavy duty construction

Stainless Steel shaft suitable for mine service vehicle mounts and harsh operating conditions.

Easy maintenance

Featuring simple maintenance anodised aluminium meter body.



Simple and easy to operate display

Clear digit display, simple programming and easy operation with robust powder coated steel register mount.

High quality hose and fittings

Capable of handling multiple fluids and tough conditions.

Small footprint

Suitable for service vehicle and narrow footprint requirements.

Part Number	FHX01215-01	FHX01915-01
Application	Oil/Diesel	Oil/Diesel
Hose Size (ID)	12mm (1/2")	19mm (3/4")
Hose Length	15m	15m
Hose Material	Wire Reinforced Rubber (SAE 100R1)	Wire Reinforced Rubber (SAE 100R2)
Working Pressure	2000 psi	1250 psi
Max Temperature	80° C	80° C
Reel Inlet	1/2" BSP (F)	3/4" BSP (F)
Hose Outlet	1/2" BSP (M)	3/4" BSP (M)
Meter Flow Rate	2 - 30 L/min	3 - 80 L/min
Meter Accuracy	0.5%	0.5%
Flow Meter Material	Aluminium	Aluminium
Reel Dimension	Reel 1	Reel 2

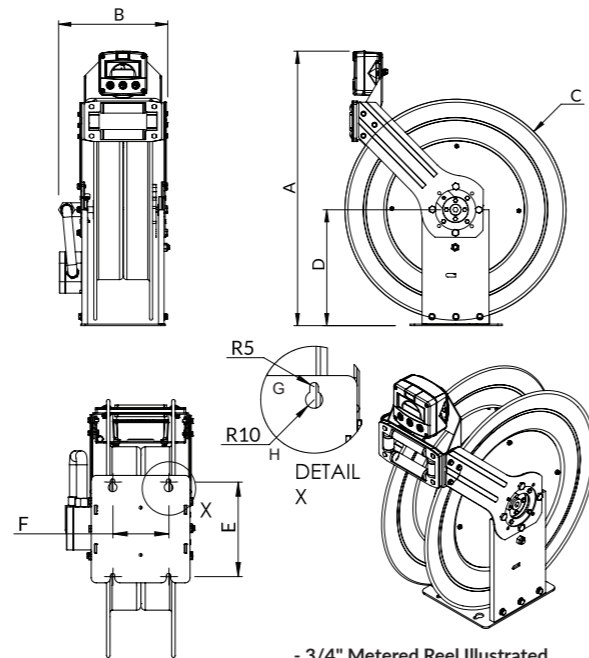

- 3/4" Metered Reel Illustrated
- Dimensions are in mm

Applications:

Automotive industry, transport workshop, truck workshop, regional farming centre, farming industry, mining service centre.

Reel Dimension	A	B	C	D	E	F	G	H	Min Bend Radius
Reel 1	690	187	Ø515	280	216	130	R4.8	R10	140
Reel 2	745	296	Ø600	315	220	130	R5	R10	190

F-SERIES CRADLE METERED

The F-Series Metered hose reel represents the first hose reel developed worldwide with integrated flow meter and flow register. Offering unparalleled simplicity for OEMs, installers and users alike, there is no longer any need for separate mounting of meters, intermediate plumbing or vulnerable wiring between meters and registers. The reel comes completely fitted and wired to be placed in situ ready to function. The only installation required is bolting the unit down and the connection of the inlet fluids and outlet control. Although equally at home in static workshop situations, the F-Series range of metered hose reels has been specifically designed to meet the rigors of the mobile lube service vehicle.



Integrated Meter

Meter unit is protected by integration behind reel frame

Durable heavy duty construction

Stainless Steel shaft suitable for mine service vehicle mounts and harsh operating conditions.

Cradle Structure

Metering unit fitted to reel with all required connection



Simple and easy to operate display

Clear digit display, simple programming and easy operation with robust powder coated steel register mount.

High quality hose and fittings

Capable of handling multiple fluids and tough conditions.

Small footprint

Suitable for service vehicle and narrow footprint requirements.

Part Number	FCXD2515-01	FCXD3815-02
Application	Oil/Diesel	Oil/Diesel
Hose Size (ID)	25mm (1")	38mm (1 - 1/2")
Hose Length	15m	15m
Hose Material	Wire Reinforced Rubber (SAE 100R1)	
Working Pressure	1000 psi	500 psi
Max Temperature	80° C	80° C
Reel Inlet	1" BSP (F)	1 - 1/2" NPT (F)
Hose Outlet	1" BSP(M)	1 - 1/2" NPT (M)
Meter Flow Rate	6 - 120 L/min	10 - 250 L/min
Meter Accuracy	0.5%	0.5%
Flow Meter Material	Aluminium	Aluminium
Reel Dimension	Reel 1	Reel 2

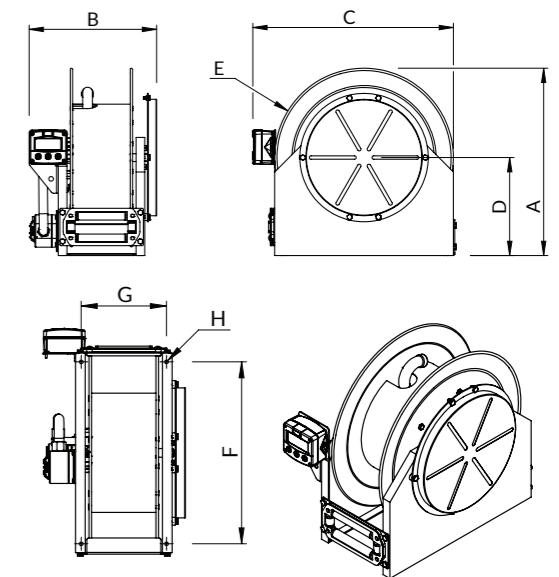

- 1" Metered Reel Illustrated
- Dimensions are in mm

Applications:

Automotive industry, transport workshop, truck workshop, regional farming centre, farming industry, mining service centre.

Reel Dimension	A	B	C	D	E	F	G	H	Min Bend Radius
Reel 1	650	442	696	340	Ø620	565	265	Ø11 x 4	180
Reel 2	728	488	811	370	Ø715	660	350	Ø14 x 6	130

Retracta E Series

E-SERIES

Retracta E-Series fully enclosed hose reels have been developed to serve the needs of the Automotive industry. The neat, narrow design accommodates high density mounting in tight workshop bay environments. The E-Series hose reel is enclosed in a powder coated steel housing designed to protect against the ingress of contaminants while offering a sleek, clean appearance. Quality, industry standard hose and fitting used throughout. Fully repairable via simple side panel removal.



Narrow body

Made from powder coated, pressed steel for rigidity and protection.
Narrow footprint allows close mounting

Fully repairable

All parts available, no special tools required

Easy tensioning mechanism

Easy access to tensioning device.
No special tools required.



Easy access to swivel
No need to disassemble the entire reel to access the swivel for maintenance or hose change

Models available for multiple fluids

Oil, coolant, grease, compressed air and water

Includes feeder hose

Part Number	ESGR0610-01	ESAW1015-01	ESAW1210-01	ESO1210-01
Application	Grease	Air/Water	Air/Water	Oil
Hose Size (ID)	6mm (1/4")	10mm (3/8")	12mm (1/2")	12mm (1/2")
Hose Length	10m	15m	10m	10m
Hose Material	Wire Reinforced Rubber	Reinforced PVC	Reinforced PVC	Wire Reinforced Rubber (SAE 100R1)
Working Pressure	4000 psi	200 psi	200 psi	1000 psi
Max Temperature	70° C	50° C	50° C	70° C
Reel Inlet	1/4" BSP (F)	3/8" BSP (F)	1/2" BSP (F)	1/2" BSP (F)
Hose Outlet	1/4" BSP (M)	3/8" BSP (M)	1/2" BSP (M)	1/2" BSP (M)

Applications:
Automotive industry,
Transport workshop,
Truck workshop,
Regional farming centre,
Farming industry.

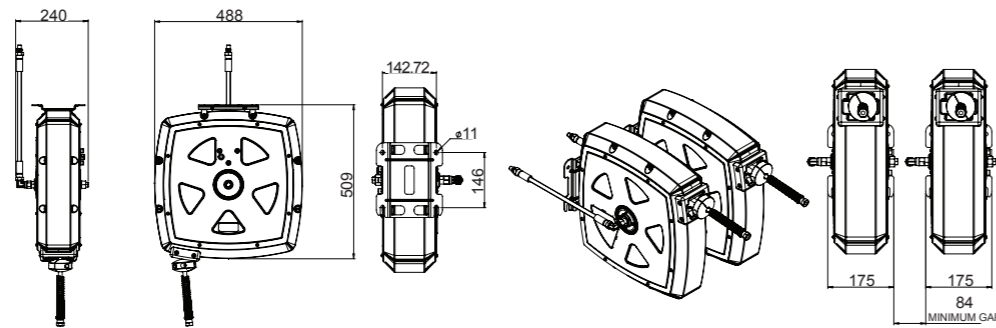

Recommended to be used with:



Retracta H Series



H-SERIES

Retracta H-Series composite hose reels offer superior impact and corrosion resistance thanks to the ABS drum. These reels are perfect for the rigours of transport and general industry. The light weight drum fittings and sturdy twin pedestal design allow fitment in fixed as well as mobile applications. Quality, industry standard hose and fitting used throughout. Fully repairable and comes with a 5 Year warranty.



Fully repairable

Industry standard hose and fitting

Stainless Steel 316 reel inlet,
PVC-PU hose



Sturdy Construction
Powder coated steel frame with high strength ABS drum

Full size flow path
3/4" flow path reduces pressure drop

Part Number	HAB1908-01
Application	AdBlue® / DEF
Hose Size (ID)	19mm (3/4")
Hose Length	8m
Hose Material	PVC - PU
Working Pressure	200 psi
Reel Inlet	3/4" BSP (F)
Hose Outlet	3/4" BSP (M)

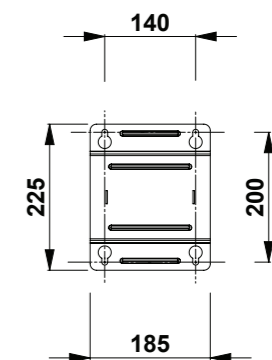

Applications:
Automotive industry,
Transport workshop,
Truck workshop,
Regional farming centre,
Farming industry.

Recommended to be used with:

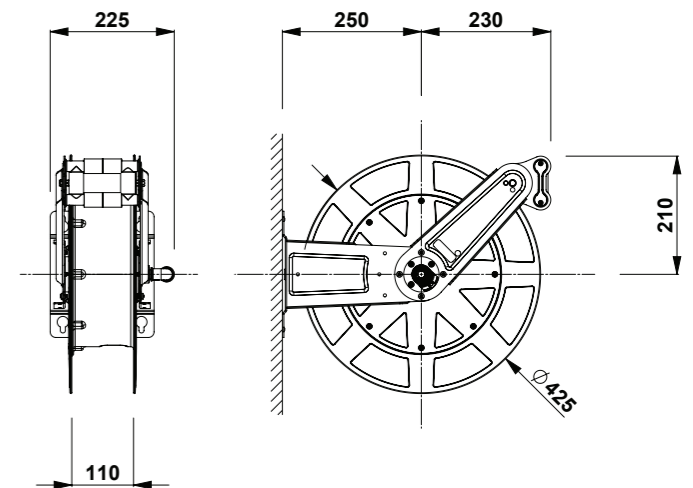

Retracta *Capability Statement*

MACNAUGHT INDUSTRIAL HOSE REELS

In addition to the range of Retracta production reels, Macnaught offers an extended range of Retracta specialised project reel types built to order for larger applications.

Designed, engineered and developed to meet and exceed the needs of the most arduous applications, Retracta specialised project reels are offered in multiple construction materials, rewind power options, fluid types, pressure ratings and hose size.

Industrial grade fixings are used throughout construction and heavy bearings sealed against dust support the moving parts.

Common Applications

- Regional farming centres
- Truck/vehicle service centre
- Refill and dispensing station
- Lube bays
- Workshops
- Service truck/vehicle mounting

Available Options

Available construction materials:

- Fabrication aluminium
- Stainless steel - 304 or 316
- Powder coated steel + Aluminium
- Powder coated steel

Additional add-on features:

- Analogue Oval Gear Meters
- Digital Oval Gear Meters
- Oval flow meter with digital output
- Oval gear meters with digital display

Reel Construction Materials:

- Powder coated steel + Aluminum
- Powder coated steel
- Stainless Steel - 304 or 316

Meters

- Digital/Signal output
- Analogue/Mechanical display
- Digital display
- Display with 4-20mA output
- Display with batch control

Application / Fluid:

- Grease
- Diesel
- Oil
- Air
- Water
- Gas



Rewind Drive Systems:

- Manual
- Hydraulic
- Pneumatic
- Electric 12V-24V Spring

Hose size range:

- 6mm (1/4") to 50mm (2")

STAINLESS STEEL HOSE REELS AIR/WATER

The NEW Retracta Stainless Steel Hose Reel range has been specially made to withstand the harshest environments, where stainless steel construction is essential. The strength of this Stainless Steel construction delivers additional durability and extension of product life, especially in high volume usage applications.



HOSE REELS

PART NUMBER	DESCRIPTION	TYPE	HOSE ID	INLET	OUTLET
FMATP1220-01-SS	RETRACTA AIR/WATER 1/2" X 20M HOSE REEL SS	SS - Twin Pedestal	1/2"	1/2" BSP F	1/2" BSP M
FMATP1920-01-SS	RETRACTA AIR/WATER 3/4" X 20M HOSE REEL SS	SS - Twin Pedestal	3/4"	3/4" BSP F	3/4" BSP M
FMATP2520-01-SS	RETRACTA AIR/WATER 1" X 20M HOSE REEL SS	SS - Twin Pedestal	1"	1" BSP F	1" BSP M

BARE REELS

PART NUMBER	DESCRIPTION	TYPE	HOSE ID	INLET	OUTLET
FMATP1220N-01-SS	RETRACTA AIR/WATER 1/2" BARE REEL SS 20M CAPACITY	SS - Twin Pedestal	1/2"	1/2" BSP F	1/2" BSP F
FMATP1920N-01-SS	RETRACTA AIR/WATER 3/4" BARE REEL SS 20M CAPACITY	SS - Twin Pedestal	3/4"	3/4" BSP F	3/4" BSP F
FMATP2520N-01-SS	RETRACTA AIR/WATER 1" BARE REEL SS 20M CAPACITY	SS - Twin Pedestal	1"	1" BSP F	1" BSP F

Rechargeable LED Inspection Light

Discover the instantaneous illumination of our new Macnaught Rechargeable LED Lights. Specially designed to deliver reliable and long-lasting brightness anywhere, anytime. Ideal for many applications whether it be the workshop, factory, home or outdoors. Cordless for convenience, the LED Inspection Light has been designed with all the hands free options you need to get your job done.



2 x Adjustable Hooks
for easy and sturdy hanging

2 x Strong Magnets on the
back for flexible placements

USB Charging Socket

WL-IL400



Main Light
Max. 400 Lumens

LED Charging Indicator
Red when charging
/Green when full

Strong Magnetic Base
at the bottom

Rechargeable LED Pen Light

Discover the instantaneous illumination of our new Macnaught Rechargeable LED Lights. Specially designed to deliver reliable and long-lasting brightness anywhere, anytime. Ideal for many applications whether it be the workshop, factory, home or outdoors. Specially designed with a slim and sleek design, the LED Pen Light is able to fit perfectly into your pockets and is easy to carry around.



Top ON/OFF Switch

Flash Light at the bottom
with 100 lumens

WL-PL120



Protective Rubber Body
for easy and ergonomic
grip during handling

Pocket Clip convenient
and fits in your pocket

Strong Magnet at the back
for easy positioning on
any metal surface

Part Number	WL-IL400
Description	Rechargeable LED Inspection Light
LED Type	Top Light: Super bright SMD LED, Main Light: Super bright COB LED
Max Lumens	400 Lumens (Main) and 120 lumens (Top light)
CRI	80CRI+ CCT:6500K
Battery	High Quality 3.7V 2600mAh Li-Ion battery
Runtime	Top Light 12 hrs Main light 3.5 hrs
Charging time	4 hrs
Ingress Protection	IP20 rating
Impact Protection	IK07
Charging Cable	USB Cable: 5V DC 1A*

Part Number	WL-PL120
Description	Rechargeable LED Pen Light
LED Type	Main Light: Super bright COB LED, Flash Light: Super bright SMD LED
Max Lumens	120 Lumens (Main) and 100 lumens (Flash light)
CRI	80CRI+ CCT:6500K
Runtime	Main light- 3.5hrs / flash light - 4.5 hrs
Charging time	2.5 hrs
Ingress Protection	IP20 rating
Impact Protection	IK07
Charging Cable	USB Cable: 5V DC 1A*

Rechargeable LED Pocket Floodlight

Discover the instantaneous illumination of our new Macnaught Rechargeable LED Lights. Specially designed to deliver reliable and long-lasting brightness anywhere, anytime. Ideal for many applications whether it be the workshop, factory, home or outdoors.

With 3 Brightness levels to choose from, the LED Pocket Flood Light is ready when you are. Designed for long-lasting brightness and durability, the LED Floodlight will deliver up to 2100 Lumens.



180° Adjustable Handle for easy handling

Super Strong Magnet on the handle for rigid placement

WL-FL1400

1400 Lumens at 120° dispersed range

400 Lumens at 20° direct range

3 LED Battery level indicators

Rechargeable LED Area Light

Discover the instantaneous illumination of our new Macnaught Rechargeable LED Lights. Specially designed to deliver reliable and long-lasting brightness anywhere, anytime. Ideal for many applications] whether it be the workshop, factory, home or outdoors. High-performing, and long-lasting, the LED Area Light can deliver brightness for up to 24 hours.



Brightness - Min-Max: 60-1000 Lumens

Stepless Dimming Switch for easy setting up the brightness needed

Power Bank Max. 5V 2A

WL-AL1000

180° Adjustable Head for easy focussing and direction

USB Port for Power Bank and Charging

Hook and Magnet on the bottom for easy hanging and positioning the light

Part Number	WL-FL1400
Description	Rechargeable LED Pocket Floodlight
LED Type	Super bright COB LED, Spotlight: Super bright COB LED
Max Lumens	Flood Light: 1400/ 700 / 350 lumens Spot Light: 400 lumens
CRI	80 CRI+, CCT: 6500K
Battery	High quality 3.7V 5200mAh Li-Ion battery
Runtime	Spotlight: 6h Floodlight: 3h/ 4h/ 7.5h
Charging time	4.5 hrs
Ingress Protection	IP65 rating
Impact Protection	IK07
Charging Cable	USB Cable: 5V DC 2A

Part Number	WL-HL500
Description	Rechargeable LED Inspection Light
LED Type	Floodlight: Super bright SMD LED
Max Lumens	Flood Light: 1400/ 700 / 350 lumens Spot Light: 400 lumens
CRI	80 CRI+, CCT: 6500K
Battery	High quality 3.7V 5200mAh Li-Ion battery
Runtime	24h-1.5hrs
Charging time	3.5hrs
Ingress Protection	IP65 rating
Impact Protection	IK07

Rechargeable LED Head Lamp

Discover the instantaneous illumination of our new Macnaught Rechargeable LED Lights. Specially designed to deliver reliable and long-lasting brightness anywhere, anytime. Ideal for many applications whether it be the workshop, factory, home or outdoors. Featuring an impressive motion sensor, glow in the dark locator, and with dual power options, the LED Head Lamp does not disappoint.



Breathable and Adjustable Headband with non-slip grip on the inside layers

Press Motion Sensor button to activate and a simple wave will allow the user to turn ON/OFF the headlamp without pressing the button

Glow in the dark locator allows the user to identify the light in the dark

60° Swivel for tilting head lamp for flexible light positioning

Dual power options Dry cell battery (3xAAA) and Lithium Ion battery

Aluminium front facing housing for better heat dissipation

Aluminium front facing housing for better heat dissipation

WL-HL500



Rechargeable LED Slimline Work Light

Discover the instantaneous illumination of our new Macnaught Rechargeable LED Lights. Specially designed to deliver reliable and long-lasting brightness anywhere, anytime. Ideal for many applications whether it be the workshop, factory, home or outdoors. The Rechargeable LED Slimline Work Light is your most essential work companion, offering 4 modes of LED Light.



4 Modes of LED Light Main Light / Red Light / Top Light and Spot light

Dimming Function on Main Light and Spot Light

Battery Indicator Light at the back

Hanging Hook in the base

WL-SL400

Magnetic top light to pick up screw or small metal pieces

180° Adjustable Main Light

Retractable base which can extend up to 40mm

Strong Magnetic base



Part Number	WL-HL500
Description	Rechargeable LED Head Lamp
LED Type	Osram & COB LED
Light Mode	High - Low - COB ON All ON - OFF (Sensor at any modes)
Max Lumens	400 Lumens (High Osram) / 120 Lumens (Low Osram) / 200 Lumens (COB) / 500 Lumens (Osram + COB)
Runtime	2 hrs (High Osram) / 10 hrs (Low Osram) / 4 hrs (COB) / 1.3 hrs (Osram + COB)
Light Range	55 Mts (OSRAM LED) & 10 Mts (COB LED)
Charging time	2 - 2.5 hrs
Waterproof	IP54 rating
Charging Cable	Micro USB

Part Number	WL-SL400
Description	Rechargeable LED Slimline Work Light
LED Type	Main Light - COB LED, Spot Light - SMD LED, Top Light - JINGRUI LED
Battery	Rechargeable 3.7V 2600mAh Li-ion battery Max output: Main - 400
4 Modes	White COB- Red COB- Top Light ON- OFF / Spot light ON- OFF
Runtime	3hrs
Charging time	4hrs
Charging Cable	Type C cable included

Rechargeable LED Underhood Light

Discover the instantaneous illumination of our new Macnaught Rechargeable LED Lights. Specially designed to deliver reliable and long-lasting brightness anywhere, anytime. Ideal for many applications whether it be the workshop, factory, home or outdoors. The new Rechargeable LED Underhood Light delivers reliable and long-lasting brightness in your workshop.

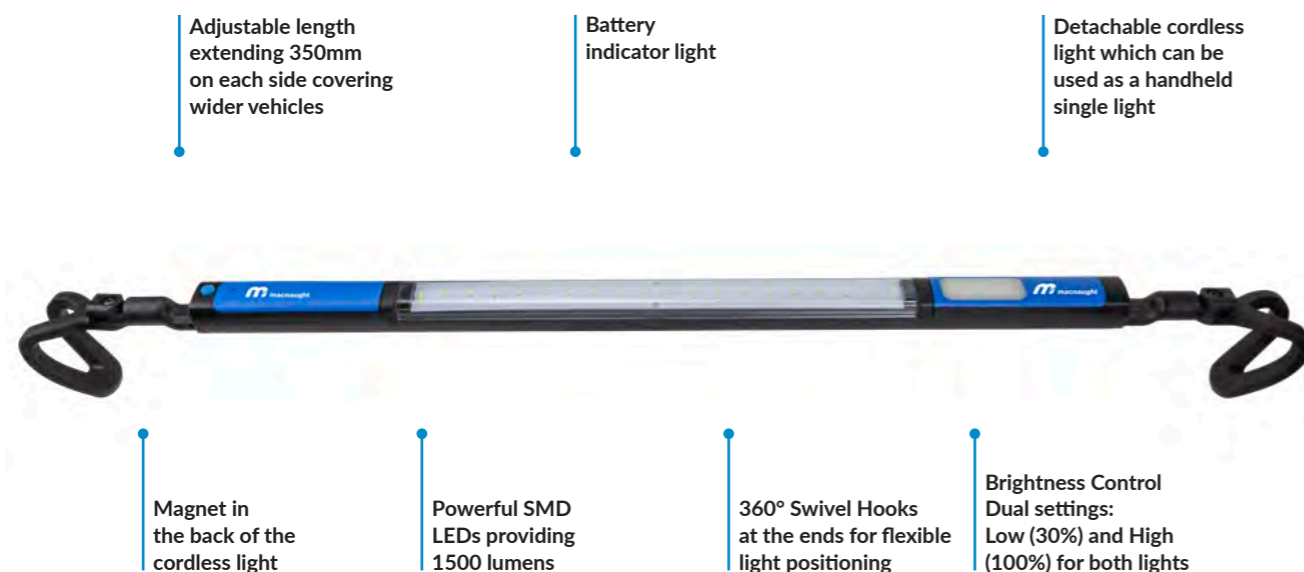

WL-UH1500

Part Number	WL-UH1500
Description	Rechargeable LED Underhood Light
LED Type	40 pcs SMD LED + 10 pcs SMD LED (detachable)
Max Output	Main Light 1500LM/350LM, Detachable Light - 250LM/75LM
Light Range	38m (Main Light) and 17m (Detachable)
Battery	Li-Ion Battery 4x18650 & 1x17335 (7.4V 5200mAh & 7.4V 750mAh)
Function	On / Off Switch (Mode: High (100%) - OFF - Low (30%) - OFF)
Runtime	Main Light: 3 hrs/8 hrs; Detachable Light: 2.5 hrs/8hrs
Charger	12V 2.5A
Charging time	4 - 5hrs

Rechargeable LED Multi-Function Work Light Set

Discover the instantaneous illumination of our new Macnaught Rechargeable LED Lights. Specially designed to deliver reliable and long-lasting brightness anywhere, anytime. Ideal for many applications] whether it be the workshop, factory, home or outdoors. The Rechargeable LED Multi-Function Work Light Set has been designed for when flexible lighting is needed.



WL-SET350

Part Number	WL-SET350
Description	Torch Base
Function Light Mode	LOW-HIGH-OFF
Battery	3.7V/2200mah
Charging time	4hrs
Waterproof	IP54 rating
Runtime	3hrs
Charger	USB cable and 240V charger - (5V/1A) /DC
Description	Torch Head
LED Type	CREE XP-G LED
Max Lumens	280 lumens (High) & 140 Lumens (LOW)
Runtime	2.5 hrs (H) & 5 hrs (L)
Weight	68g
Description	Flexible Inspection Light
LED Type	CREE XP-G LED
Max Lumens	200 lumens (High) & 100 Lumens (LOW)
Runtime	5.5 hrs (H) & 8.5 hrs (L)
Weight	100g
Description	Work Light
LED Type	COB LED
Max Lumens	350 lumens (High) & 175 Lumens (LOW)
Runtime	1.5 hrs (H) & 4 hrs (L)
Weight	86g

MACNAUGHT Pty Ltd
41-49 Henderson Street
Turrella, New South Wales
Australia 2205

T +61 2 9567 0401
F +61 2 9597 7773
E info@macnaught.com
W www.macnaught.com

For Macnaught warranty,
terms and conditions see
macnaught.com/warranty

To subscribe to our mailing list go to
macnaught.com/subscribe

©Macnaught Pty Ltd, 2017.